

# N5193A<sup>1</sup>

## UXG Agile Signal Generator

10 MHz to 20 or 40 GHz



1. Because of the high-performance characteristics of the N5193A, A US export license (EAR Category 3, 3A002.d) is required.

## Definitions and Conditions

**Specification (spec):** represents warranted performance of a calibrated instrument that has been stored for a minimum of 2 hours within the operating temperature range of 0 to 55 °C, unless otherwise stated, and after a 1 hour warm-up period. The specifications include measurement uncertainty. Data represented in this document are specifications unless otherwise noted.

**Typical (typ):** describes additional product performance information. It is performance beyond specifications that 80% of the units exhibit with a 95% confidence level at room temperature (approximately 25 °C). Typical performance does not include measurement uncertainty.

**Nominal (nom):** describes the expected mean or average performance, or an attribute whose performance is by design, such as the 50 Ω connector. This data is not warranted and is measured at room temperature (approximately 25 °C).

**Measured (meas):** describes an attribute measured during the design phase for purposes of communicating expected performance, such as amplitude drift vs. time. This data is not warranted and is measured at room temperature (approximately 25 °C).

All of the above apply when using the instrument in its default settings unless otherwise stated.

This data sheet provides a summary of the key performance parameters for the N5193A UXG Agile Signal Generator. All options referenced in this data sheet are described in the UXG configuration guide (5992-1116EN).

Unless otherwise noted, this data sheet applies to units with serial numbers ending with 5646xxxx or greater and firmware revision A.01.86.

# Specifications

## Frequency

Range		
	Specified range	Tunable range
Option 520	10 MHz to 20 GHz	10 MHz to 21.5 GHz
Option 540	10 MHz to 40 GHz	10 MHz to 40 GHz
CW frequency resolution		
Standard	10 kHz	
Option FR1	0.001 Hz	
Frequency switching modes		
Phase continuous switching	Minimizes phase changes and spectral splatter when transitioning to a new frequency within a band.	
Phase coherent switching	When returning to a prior frequency, returns to the prior phase trajectory at that frequency, assuming the same setup conditions. Some temporary amplitude and phase changes may occur during transitions.	
Phase offset		
	Adjustable in 0.1° increments (nom)	
Accuracy		
	Accuracy is equivalent to the internal or external frequency reference in use.	
	Choices are the internal timebase reference oscillator, the external reference input, the system sync input, and the 6 GHz input.	
Internal timebase reference oscillator		
Initial calibration accuracy	$\pm 5 \times 10^{-8}$	
Aging rate <sup>1</sup>	$\pm 3 \times 10^{-8}$ /year or $\pm 2.5 \times 10^{-10}$ /day after 30 days	
Temperature effects	$\pm 4.5 \times 10^{-9}$ (nom) from 0 to 55 °C	
Electronic frequency control (EFC) sensitivity	-0.04 ppm/V (nom) from -10 V to +10 V	
External 10 MHz reference input		
Frequency	10 MHz	
Modes	Manually or automatically selected	
Lock range	$\pm 1.0$ ppm (nom)	
Input amplitude	6 dBm $\pm$ 6 dB (nom). To optimize phase noise use 6 dBm $\pm$ 2 dB (nom)	
Input impedance	50 $\Omega$ (nom)	
Other reference choices		
System sync in/out	See the Synchronization Section	
6 GHz in/out	See the Synchronization Section	
Reference output (10/100 MHz output)		
Frequency	10 MHz or 100 MHz, user selectable	
Amplitude	7 dBm (nom) into 50 $\Omega$ load	

1. Not verified by Keysight N7800A TME Calibration and Adjustment Software. Daily aging rate may be verified as a supplementary chargeable service, on request.

Frequency Bands (Frequency Mode A, Default)

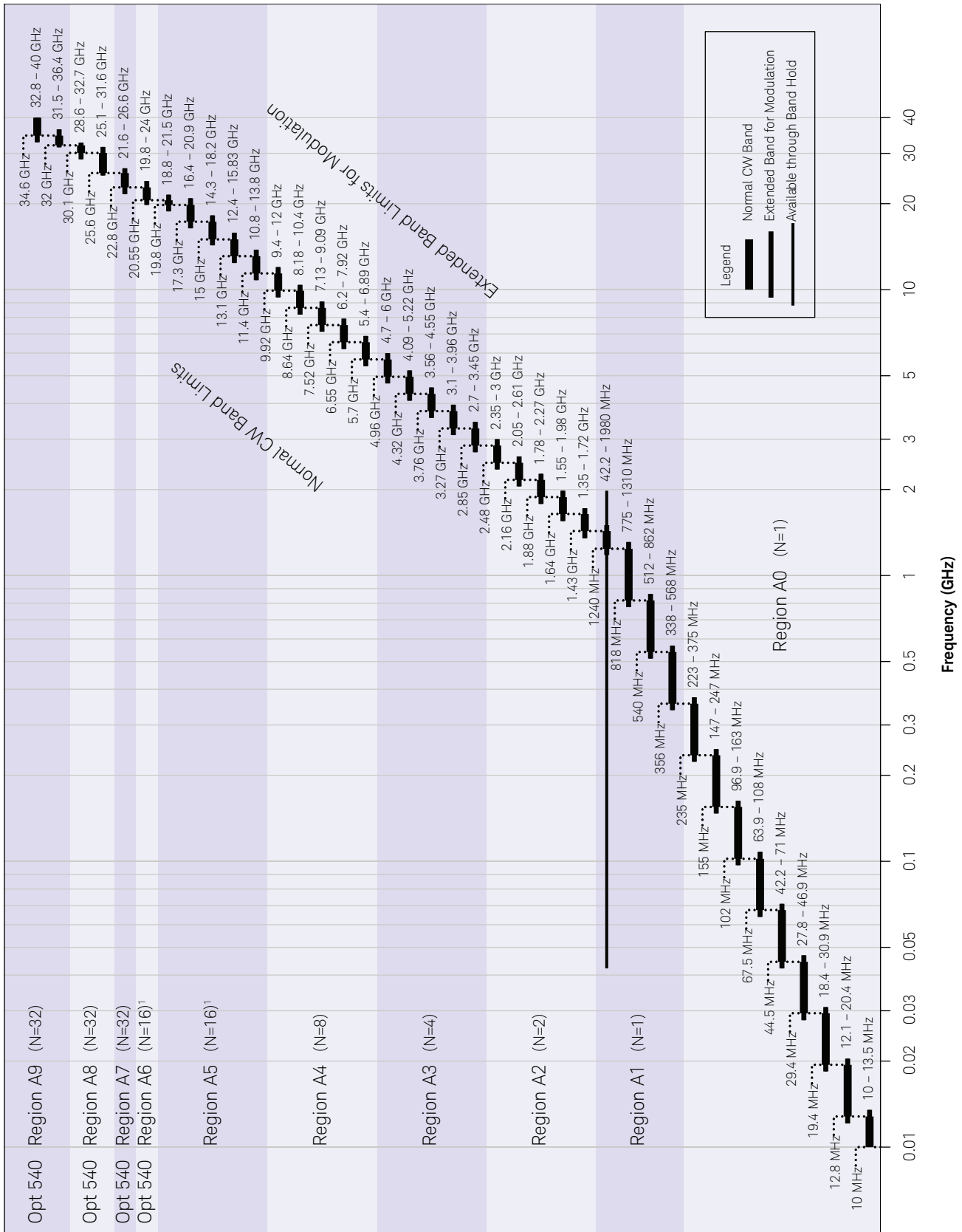

1. In Option 520, the 18.8 to 21.5 GHz band behaves like it is part of Region A5.  
 2. In Option 540, the 18.8 to 21.5 GHz band behaves like it is part of Region A6.

Frequency Bands (Frequency Mode B)

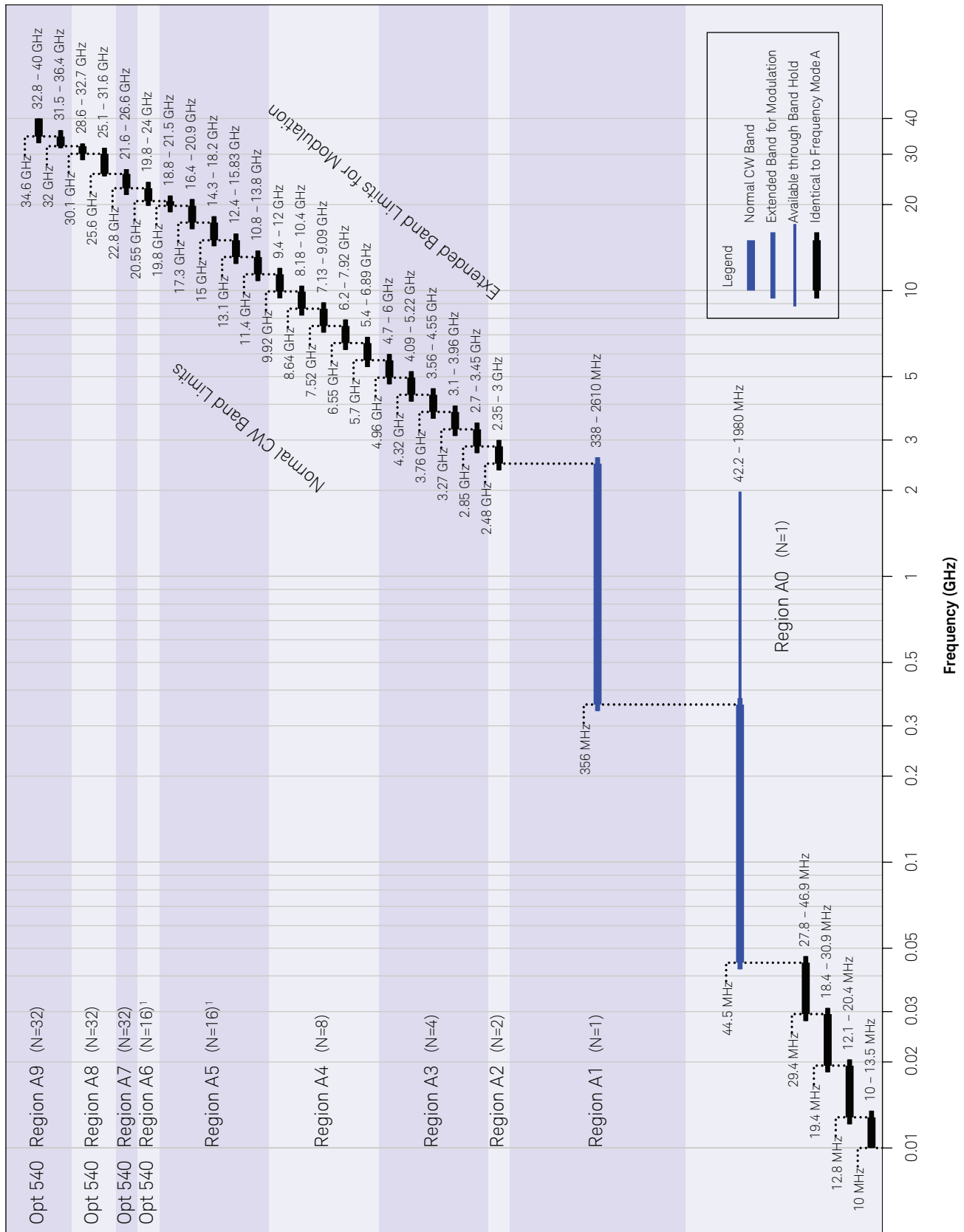

1. In Option 520, the 18.8-21.5 GHz band behaves like it is part of Region A5. In Option 540, the 18.8-21.5 GHz band behaves like it is part of Region A6.

## Frequency band overview

Default bands (Mode A)	Provide lowest harmonics and spurious signals.
42.2 to 1980 MHz band (Mode B)	Provides wider bandwidth at low frequencies for wider chirps, wider FM, and better pulse shape.
338 to 2610 MHz band (Mode B)	Provides wider bandwidth at low frequencies for wider chirps, wider FM, and better pulse shape. Reduces pulse video feedthrough.

## Power

### Dual attenuator specified frequency range (Option AT2)

	Option 520	Option 540
Electronic agile attenuator	10 MHz to 20 GHz	10 MHz to 40 GHz
Mechanical step attenuator	10 MHz to 20 GHz	10 MHz to 40 GHz

### Dual attenuator step size (Option AT2)

Electronic agile attenuator	0 dB to 65 dB in 5 dB steps, for frequencies up to 40 GHz, or bypassed
Mechanical step attenuator	0 dB to 85 dB in 5 dB steps, for frequencies up to 40 GHz

### Maximum output power (Option 520)

Frequency	Standard	Option AT2 Electronic attenuator bypassed	Option AT2 <sup>1</sup> Electronic attenuator inline
10 MHz to 13 GHz	10 dBm	10 dBm	-1 dBm
> 13 GHz to 18 GHz	10 dBm	10 dBm	-4 dBm
> 18 GHz to 20 GHz	10 dBm	10 dBm	-6 dBm

### Maximum output power (Option 540)

Frequency	Standard	Option AT2 Electronic attenuator bypassed	Option AT2 <sup>1</sup> Electronic attenuator inline
10 MHz to 13 GHz	10 dBm	8 dBm	-3 dBm
> 13 GHz to 18 GHz	10 dBm	8 dBm	-5 dBm
> 18 GHz to 20.55 GHz	7 dBm	6 dBm	-10 dBm
> 20.55 GHz to < 25.6 GHz	10 dBm	10 dBm	-7 dBm
25.6 GHz to 32 GHz	7 dBm	6 dBm	-8 dBm
> 32 GHz to 40 GHz	7 dBm	7 dBm	-7 dBm

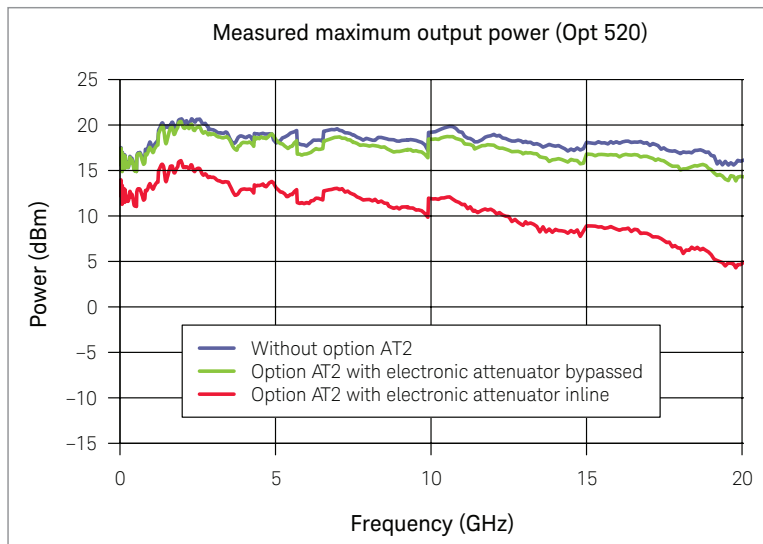

- Note that during EW simulations using option AT2 agile power capability, these are the maximum power values available in the agile power range. Bypass mode is not recommended for EW simulations that require > 20 dB agile power capability, as the mechanical switches used to switch between bypass and inline modes can take as long as 20 ms (nom) to change modes.

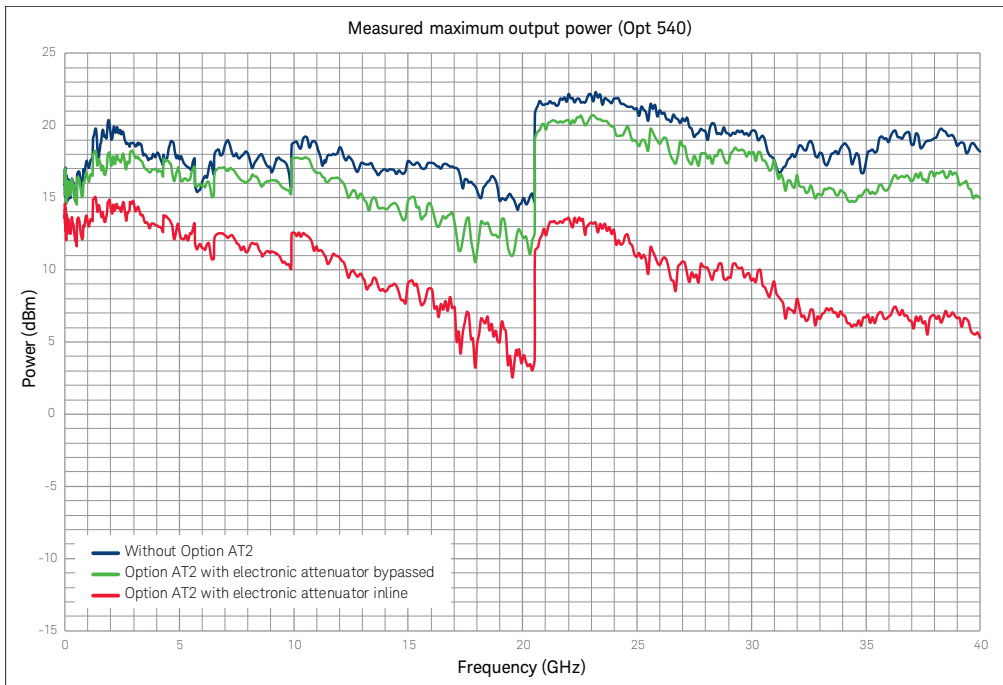

Minimum settable output power			
Frequency	Standard	Option AT2 Electronic attenuator bypassed	Option AT2 Electronic attenuator inline
10 MHz to 20 GHz	-10 dBm	-95 dBm	-130 dBm
> 20 GHz to 40 GHz (Option 540)	-10 dBm	-95 dBm	-130 dBm
Agile power range			
Frequency	Standard	Option AT2 Electronic attenuator bypassed	Option AT2 Electronic attenuator inline
Option 520			
10 Hz to 20 GHz	20 dB (nom)	20 dB (nom)	90 dB (nom)
Option 540			
10 Hz to 18 GHz	20 dB (nom)	20 dB (nom)	90 dB (nom)
> 18 to 20.55 GHz	17 dB (nom)	20 dB (nom)	90 dB (nom)
> 20.55 to < 25.6 GHz	20 dB (nom)	10 dB (nom)	80 dB (nom)
25.6 GHz to 40 GHz	17 dB (nom)	10 dB (nom)	80 dB (nom)
Leveling modes			
ALC on	Internal power leveling		
ALC off <sup>1</sup>	No power leveling		
ALC off with power alignment	Power alignment is a routine that improves level accuracy with ALC off. It aligns the power level with ALC off to match the power level with ALC on at a customer specified power level. It should be run at regular intervals and whenever the operating temperature changes $\pm 5$ °C from the alignment temperature.		
RF Gating			
Turns RF power on/off with external trigger			

1. For EW simulations using option AT2 agile power capability, it is strongly recommended to operate with ALC mode off after running power alignment. If ALC mode is left on, switching speed performance will be significantly reduced.

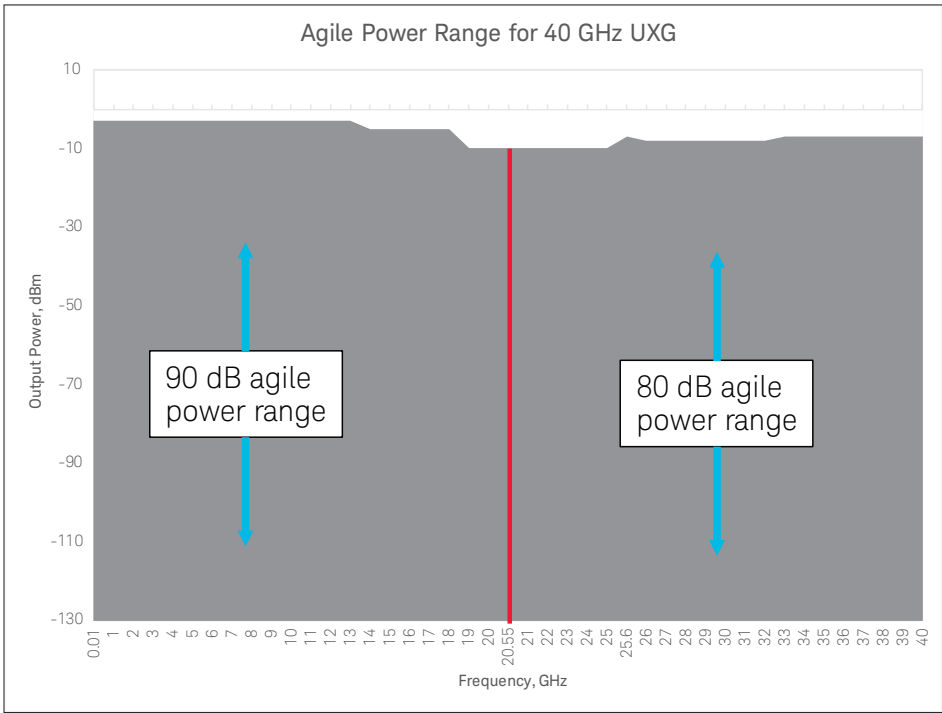
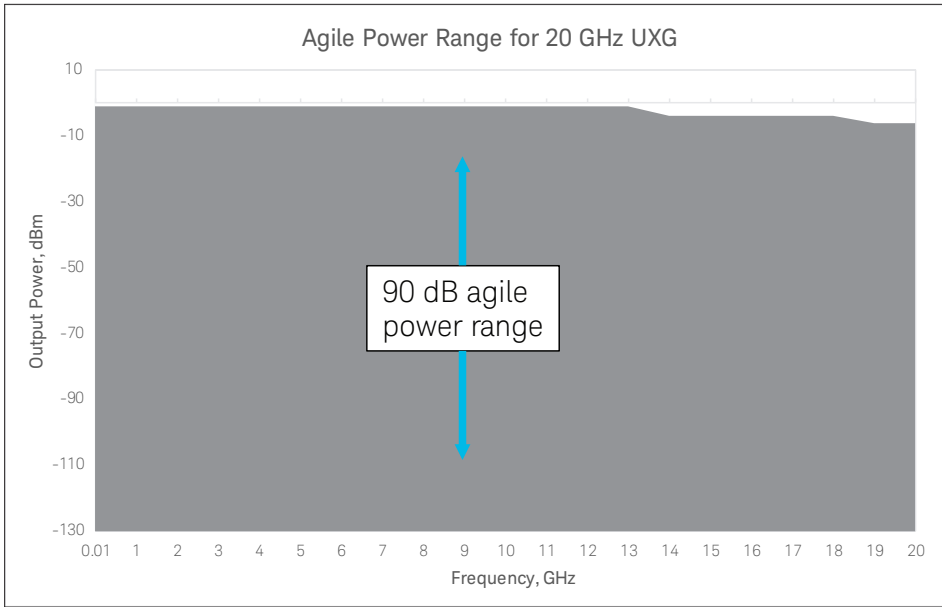



Amplitude resolution					
0.01 dB					
Level accuracy (Option 520) <sup>1</sup>					
<b>Specifications apply for CW signals that do not exceed the maximum specified power. For instruments with Option 1ED Type-N connectors, specifications apply below 18 GHz and performance is typically degraded 0.2 dB above 18 GHz.</b>					
Output power (Standard)				ALC on	ALC off <sup>2,3</sup>
10 to 0 dBm				± 1.4 dB (typ)	± 2.0 dB (typ)
Output power (Option AT2)	Mechanical attenuator	Electronic attenuator	ALC on		ALC off <sup>2,3</sup>
10 to 2 dBm	0 dB	Bypass	± 1.5 dB		± 2.0 dB
< 2 to -10 dBm	0 dB	Bypass	± 1.6 dB (typ)		± 2.5 dB (typ)
10 to -75 dBm	Auto	Bypass	± 1.5 dB		± 2.0 dB
-3 to -65 dBm	0 dB	Inline	± 1.5 dB		± 2.0 dB <sup>4</sup>
< -65 to -90 dBm	0 dB	Inline	± 2.0 dB		± 2.5 dB <sup>4</sup>
5 to -10 dBm	Auto	Auto	± 1.5 dB		± 2.0 dB <sup>4</sup>
< -10 to -80 dBm	Auto	Auto	± 1.6 dB		± 2.5 dB <sup>4</sup>
Level accuracy (Option 540, frequency ≤ 20 GHz) <sup>1</sup>					
<b>Specifications apply for CW signals that do not exceed the maximum specified power.</b>					
Output power (Standard)				ALC on	ALC off <sup>2,3</sup>
10 dBm to 0 dBm				± 1.4 dB (typ)	± 2.0 dB (typ)
Output power (Option AT2)	Mechanical attenuator	Electronic attenuator	ALC on		ALC off <sup>2,3</sup>
10 to 0 dBm	0 dB	Bypass	± 1.5 dB		± 2.0 dB
< 0 to -10 dBm	0 dB	Bypass	± 1.6 dB (typ)		± 2.5 dB (typ)
10 to -75 dBm	Auto	Bypass	± 1.5 dB		± 2.0 dB
-15 to -65 dBm	0 dB	Inline	± 1.5 dB		± 2.0 dB
< -65 to -90 dBm	0 dB	Inline	± 2.0 dB		± 2.5 dB <sup>4</sup>
5 to -10 dBm	Auto	Auto	± 1.5 dB		± 2.0 dB <sup>4</sup>
< -10 to -80 dBm	Auto	Auto	± 1.6 dB		± 2.5 dB <sup>4</sup>
Level accuracy (Option 540, frequency > 20 GHz)					
<b>Specifications apply for CW signals that do not exceed the maximum specified power.</b>					
Output power (Standard)				ALC on	ALC off <sup>2,3</sup>
10 dBm to 0 dBm				± 1.4 dB (typ)	± 4.5 dB (typ)
Output power (Option AT2)	Mechanical attenuator	Electronic attenuator	ALC on		ALC off <sup>2,3</sup>
10 to 0 dBm	0 dB	Bypass	± 1.8 dB		± 4.5 dB
< 0 to -10 dBm	0 dB	Bypass	± 1.6 dB (typ)		± 5.0 dB (typ)
10 to -50 dBm	Auto	Bypass	± 1.8 dB		± 4.5 dB
< -50 to -75 dBm	Auto	Bypass	± 2.2 dB		± 4.5 dB
-15 to -65 dBm	0 dB	Inline	± 2.0 dB		± 4.5 dB
5 to -10 dBm	Auto	Auto	± 2.0 dB		± 4.5 dB
< -10 to -80 dBm	Auto	Auto	± 2.6 dB		± 4.5 dB
Agile power linearity (frequency ≤ 20 GHz with Option AT2) <sup>3</sup>					
<b>Measured relative to -5 dBm for Option 520 and relative to -15 dBm for Option 540 with the mechanical step attenuator set to 0 dB and the electronic attenuator inline.</b>					
10 MHz to 13 GHz	± 0.4 dB (typ) for relative power from 0 to -75 dB				
> 13 GHz to 20 GHz	± 0.5 dB (typ) for relative power from 0 to -75 dB				
Agile power linearity (frequency > 20 GHz with Options 540 and AT2) <sup>3</sup>					
<b>Measured relative to -15 dBm with the mechanical step attenuator set to 0 dB and the electronic attenuator inline.</b>					
> 20 GHz to 40 GHz	± 1.8 dB (typ) for relative power from 0 to -60 dB				
	± 2.2 dB (typ) for relative power from -60 to -65 dB				

- Specifications shown represent uncorrected performance at the RF output port. Level accuracy at the DUT input can be significantly improved by running the UXG user amplitude correction routine with a power sensor.
- Specifications apply after running power alignment at +4 dBm power level. It is strongly recommended that EW simulations be performed with ALC mode off after running power alignment. If ALC mode is left on, switching speed performance will be significantly reduced.
- The Power Alignment routine aligns ALC off level accuracy performance to ALC ON performance at a customer specified power. It should be run at regular intervals, and whenever the operating temperature changes ± 5 °C from the alignment temperature. For optimal performance in applications where the instrument will be used at more than one power level, execute power alignment at a power level < 5 dBm and with the output attenuation set to the desired operating condition.
- For frequencies > 17 to 20 GHz, level accuracy degrades by an additional 0.5 dB.

<b>Temperature stability</b>			
ALC on and frequency $\leq$ 20 GHz	$\pm 0.02$ dB/ $^{\circ}$ C (typ)		
ALC on and frequency $>$ 20 GHz	$\pm 0.04$ dB/ $^{\circ}$ C (typ)		
ALC off and frequency $\leq$ 20 GHz	$\pm 0.07$ dB/ $^{\circ}$ C (typ)		
ALC off and frequency $>$ 20 GHz	$\pm 0.15$ dB/ $^{\circ}$ C (typ)		
<b>Output impedance</b>			
	50 $\Omega$ (nom)		
<b>SWR (meas) without Option AT2</b>			
Frequency	Option 520 with 1ED	Option 540	
10 MHz to 1 GHz	1.4 : 1	1.4 : 1	
$>$ 1 GHz to 2 GHz	1.4 : 1	1.5 : 1	
$>$ 2 GHz to 18 GHz	1.7 : 1	2 : 1	
$>$ 18 GHz to 20 GHz	1.9 : 1	2 : 1	
$>$ 20 GHz to 40 GHz	N/A	3 : 1	
<b>SWR (meas) with Option AT2, electronic attenuator bypassed, mechanical attenuator = 0 dB</b>			
Frequency	Option 520 without 1ED	Option 520 with 1ED	Option 540
10 MHz to 1 GHz	1.4 : 1	1.4 : 1	1.4 : 1
$>$ 1 GHz to 2 GHz	1.4 : 1	1.4 : 1	1.5 : 1
$>$ 2 GHz to 18 GHz	1.7 : 1	1.7 : 1	2 : 1
$>$ 18 GHz to 20 GHz	1.8 : 1	1.8 : 1	2 : 1
$>$ 20 GHz to 40 GHz	N/A	N/A	2 : 1
<b>SWR (meas) with Option AT2, electronic attenuator bypassed, mechanical attenuator <math>&gt;</math> 0 dB</b>			
Frequency	Option 520 without 1ED	Option 520 with 1ED	Option 540
10 MHz to 1 GHz	1.2 : 1	1.2 : 1	1.2 : 1
$>$ 1 GHz to 2 GHz	1.2 : 1	1.2 : 1	1.2 : 1
$>$ 2 GHz to 18 GHz	1.5 : 1	1.5 : 1	1.4 : 1
$>$ 18 GHz to 20 GHz	1.5 : 1	1.5 : 1	1.4 : 1
$>$ 20 GHz to 40 GHz	N/A	N/A	1.5 : 1
<b>SWR (meas) with Option AT2, electronic attenuator inline</b>			
Frequency	Option 520 without 1ED	Option 520 with 1ED	Option 540
10 MHz to 1 GHz	1.6 : 1	1.6 : 1	1.6 : 1
$>$ 1 GHz to 2 GHz	1.5 : 1	1.5 : 1	1.5 : 1
$>$ 2 GHz to 18 GHz	1.7 : 1	1.7 : 1	1.7 : 1
$>$ 18 GHz to 20 GHz	1.7 : 1	1.7 : 1	1.7 : 1
$>$ 20 GHz to 40 GHz	N/A	N/A	1.8 : 1
<b>Maximum reverse power</b>			
	1/2 Watt, 0 VDC		
<b>User corrections</b>			
The User Corrections capability can apply corrections across frequency for amplitude, phase and time. Corrections can only be applied when the UXG operates in Streaming Mode. Amplitude-only corrections can be done with a power sensor. In order to maximize agile dynamic range, it may necessary to modify mechanical attenuator settings depending on PDW amplitude values and the peak amplitude loss being corrected.			
Number of points/table	2 to 3201		
Number of tables	Dependent on available free memory in instrument; 10,000 maximum		
Entry modes	USB/LAN direct power meter control, LAN to GPIB and USB to GPIB, remote bus, and manual USB/GPIB power meter control		

## Switching speed

Agile switching modes			
Fast CW Switching Mode	The fast control port (Options CC1 or CC2) provides agile switching of CW frequency at a constant amplitude with the lowest latency. When using the CC1 Interface Card, Option FR1 is required.		
Normal Mode	The fast control port (Options CC1, CC3, or CC4) provides agile switching of frequency, phase, amplitude, pulse modulation, frequency modulation, phase modulation, and chirp. Option CC2 provides agile switching of frequency only.		
List Mode	Internal list memory and a hardware trigger provide agile switching of frequency, phase, amplitude, pulse modulation, frequency modulation, phase modulation, and chirp.		
Streaming Mode	The LAN interface or fast control port (Options CC1, CC3, or CC4) is asynchronous and utilizes time stamps to provide agile switching of frequency, phase, amplitude, pulse modulation, frequency modulation, phase modulation and chirp. PDWs can also be streamed via the internal hard drive. Option PM1 is required to stream.		
Frequency transition types	Transition examples		
Type 1	A frequency change in which the initial frequency and final frequency are in the same band per the frequency band diagrams in the frequency section, but not in region A0. 3.77 GHz to 4.3 GHz 35 GHz to 39 GHz		
Type 2	A frequency change in which the initial frequency and final frequency are in the same region per the frequency band diagrams in the frequency section, but not in region A0. 1 GHz (A1) to 500 MHz (A1) 34 GHz (A9) to 40 GHz (A9)		
Type 3	A frequency change in which the initial frequency and final frequency are in regions A1 through A5 per the frequency band diagrams in the frequency section. 1 GHz (A1) to 18 GHz (A5) 10 GHz (A4) to 3 GHz (A2)		
Type 4	A frequency change not described in Types 1, 2, or 3. 1 GHz (A1) to 37 GHz (A9) 28 GHz (A8) to 10 GHz (A4) 22 GHz (A6) to 39 GHz (A9)		
RF transition speed			
<b>For frequency and phase transitions at a fixed power level, with ALC off and the electronic attenuator bypassed, for frequencies &lt; 32 GHz. Measured from the first phase change of more than 0.1 radians that occurs after the input trigger, and measured to RF phase settled. Applies to Normal, Streaming, or List Mode, not Fast CW Switching Mode.</b>			
Transition type	Standard	Option SS1	Option SS4
Type 1	95 $\mu$ s (typ)	1 $\mu$ s (typ)	50 ns (typ)
Switching speed for Normal, Streaming, or List Mode			
<b>Update rate - Determined by transition time as measured from pulse sync out or list point start to RF phase and amplitude settled with ALC off. With Option AT2, includes amplitude changes over the agile power range.</b>			
Transition type	Standard	Option SS1	Option SS4
Type 1, 2, or 3	95 $\mu$ s	1 $\mu$ s	180 ns
Type 4	95 $\mu$ s	31 $\mu$ s <sup>1</sup>	2.7 $\mu$ s
<b>Latency - measured from input trigger to RF phase and amplitude settled with ALC off. With Option AT2, includes amplitude changes over the agile power range.</b>			
Transition type	Standard	Option SS1	Option SS4
Type 1, 2 or 3	95 $\mu$ s	1.5 $\mu$ s	650 ns
Type 4	95 $\mu$ s	31 $\mu$ s <sup>1</sup>	3.2 $\mu$ s
CW switching speed for Fast CW Switching Mode <sup>2</sup>			
<b>Update rate - Determined by transition time as measured from pulse sync out to RF phase and amplitude settled at a fixed power level with ALC off.</b>			
Transition type	Standard	Option SS1	Option SS4
Type 1, 2 or 3	95 $\mu$ s	1 $\mu$ s	240 ns
Type 4	95 $\mu$ s	31 $\mu$ s <sup>1</sup>	2.7 $\mu$ s
<b>Latency - measured from input trigger to RF phase and amplitude settled at a fixed power level with ALC off.</b>			
Transition type	Standard	Option SS1	Option SS4
Type 1, 2 or 3	95 $\mu$ s	1 $\mu$ s	370 ns
Type 4	95 $\mu$ s	31 $\mu$ s <sup>1</sup>	2.9 $\mu$ s

1. For units with s/n 5646xxxx or greater, typical option SS1 type 4 switching speed is 4  $\mu$ s.
2. When using the CC1 interface card for Fast CW switching, Option FR1 is required.

### Additional contributors to switching speed

With GPIB, LAN, or USB control	Add 900 $\mu$ s (nom) from receipt of SCPI command or trigger signal.
With Opt AT2 attenuators	Add 20 ms (nom) for any change in the mechanical attenuator or bypass switch. These are controllable via GPIB, LAN, or USB. These are not controllable via list or fast control port (Options CC1, CC2, CC3, or CC4).
For frequencies in Region A0	Add 1 $\mu$ s (nom) when switching to or from any frequency in Region A0.

### Switching Speed Definitions Triggered Pulse

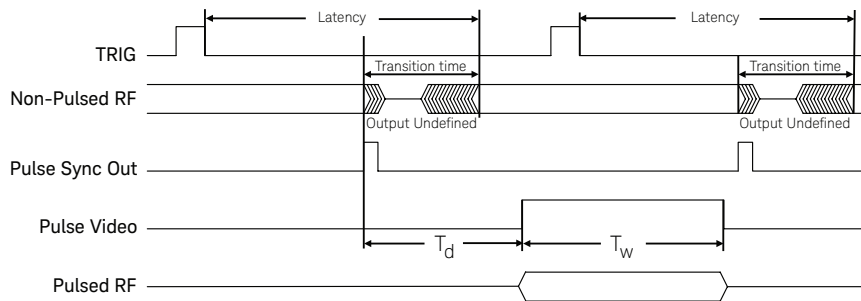

### Switching Speed Definitions List Pulse

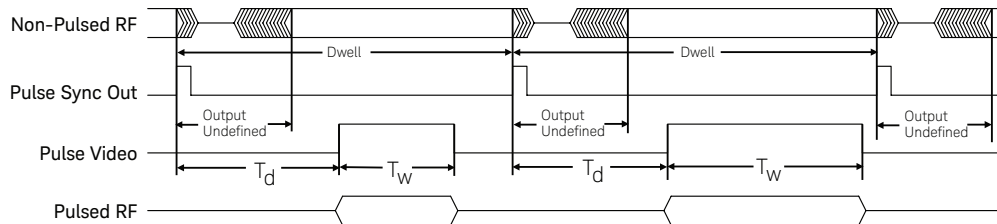

### RF phase settling criteria

#### Final frequency

10 MHz to 8.6 GHz	Measured to phase settled within 0.1 radians of final phase.
> 8.6 GHz to 17.3 GHz	Measured to phase settled within 0.2 radians of final phase.
> 17.3 GHz	Measured to phase settled within 0.3 radians of final phase.

#### RF amplitude settling criteria

Measured to amplitude settled within 1 dB of final amplitude.

## Synchronization

Multiple UXG units can be synchronized together to have phase coherent outputs. This is useful for simulating angle-of-arrival (AoA) and phased array antenna wavefronts.

Synchronization input connections	
10 MHz input	Accepts a basic external reference at 10 MHz. Achieves lower residual phase noise than a 10 MHz input at the system sync input. See the Rear Panel Connectors Section for connection details.
System sync input	Recommended external reference input for use in system environments where trigger jitter and phase stability are important. Accepts a wide variety of input frequencies. See the Rear Panel Connectors Section for connection details.
6 GHz input	Provides high stability synchronization between multiple signal generators. This is not a general 6 GHz connection. Only the 6 GHz synchronization output from another compatible signal generator should be connected. See the Rear Panel Connectors Section for connection details. For a single N5193A its 6 GHz output is fed into its own 6 GHz input.
Synchronization output connections	
10/100 MHz output	Provides a basic external reference at 10 MHz or 100 MHz. Achieves better spectral purity than the system sync output. +6.4 dBm minimum (nom). See the Rear Panel Connectors Section for connection details.
RF sync output	Recommended external reference output for use in system environments where trigger jitter and phase stability are important. Normally provides a 250 MHz output, but other frequencies are available. +10.4 dBm minimum (nom). See the Rear Panel Connectors Section for connection details.
6 GHz output	Provides high phase stability synchronization between multiple signal generations. +15 dBm minimum (nom). See the Rear Panel Connectors Section for connection details.
System sync input	
Frequency	1 to 250 MHz in 1 MHz steps. Default value is 250 MHz.
Lock range	$\pm 1.0$ ppm (nom)
Amplitude	6 dBm $\pm$ 6 dB (nom). To optimize phase noise use 6 dBm $\pm$ 2 dB (nom).
Input impedance	50 $\Omega$ (nom)
Usage	The input frequency is not auto-detected. It must be entered manually and must be accurate to within the lock range above.
RF sync output	
Frequency	10 MHz, 100 MHz, or 250 MHz, selectable. Multi-box synchronization overrides this selection and may use other frequencies.
Amplitude	12 dBm (nom)
Output impedance	50 $\Omega$ (nom)
6 GHz input	
Frequency	6 GHz
Lock range	$\pm 1.0$ ppm (nom)
Amplitude	11 dBm $\pm$ 6 dB (nom)
Input impedance	50 $\Omega$ (nom)
Usage	This input must be connected to the 6 GHz output (described below) or a similar output from another compatible signal generator. The signal generator will not function without a 6 GHz signal at this input.
6 GHz output	
Frequency	6 GHz
Amplitude	17 dBm (nom)
Output impedance	50 $\Omega$ (nom)
Usage	A rigid jumper cable is provided to connect the 6 GHz output to the 6 GHz input. The jumper can be removed to distribute this signal to other equipment. When distributing this signal to multiple UXG signal generators, approximately 12 dB of loss is permissible before distribution amplifiers are required. One of the distributed outputs from a primary signal generator must be connected back into the 6 GHz input of the primary signal generator.
Reference bandwidth	
Standard	25 Hz
Option EP1	25 Hz, 75 Hz, 400 Hz, or 2 kHz, selectable

## Normal mode

Normal mode is optimized for maximum update rate (throughput). If the fast control port (FCP) Option CC1, CC3, or CC4 is installed, it provides the capability to use pulse descriptor words (PDWs) to control frequency, amplitude, phase, pulse (include chirp or phase coding), and FM or  $\Phi$ M. With CC1, the PDW is streamed into the rear-panel FCP 100-pin connector using 46-bit wide control words. The control word information is executed synchronously upon receipt of a trigger.

## Fast CW mode

Fast CW mode is optimized for minimum latency. The FCP control over signal attributes is limited to CW frequency switching and the addition of FM/ $\Phi$ M provided this option was purchased. It is typically used with the FCP Option CC2 for compatibility with instruments used in legacy test systems. When using the CC1 interface card, Option FR1 is required.

## PDW Streaming mode

Streaming provides agile control of most of the instrument settings via a continuous stream of PDWs transferred from the internal SSD or an external source, such as a LAN or the Fast Control Port (with Option CC3 or CC4). The set of parameters controlled by Streaming include frequency, frequency band map, band adjust, relative power, phase, phase mode, pulse width, pulse start time, FM (chirp) and PM (phase coding). Each PDW consists of seven 32-bit words. The streaming PDW parameters are executed asynchronously, based on the time stamp information contained within the PDW. Option PM1 is required to stream.

<b>From file on solid state drive (SSD)</b>	
PDW streaming rate	750 k pulses/s (nom)
<b>Over LAN port</b>	
PDW streaming rate	750 k pulses/s (nom)
<b>Over fast control port (FCP) (Options CC3/CC4)</b>	
PDW streaming rate	6 M pulses/s (nom)
<b>Over CC4 10 GbE LAN interface <sup>1</sup></b>	
PDW Streaming Rate	6 M pulses/s (nom)
<b>Triggering</b>	
PDW streaming trigger	Auto, external, single, SCPI, timer, or trigger key
PDW streaming trigger types	Play, abort, or cancel
<b>Time accuracy</b>	
Pulse start time accuracy/resolution	40 ps (typ)/10 ps
Pulse fine delay accuracy/resolution	40 ps (typ)/10 ps

## List mode

List mode lets you play out a list of PDW's located in and read from the instrument's FPGA memory. The memory contains a series of list points where each list point contains multiple signal attributes. This mode supports dynamic sequencing using the external trigger ports.

<b>Operating modes</b>	
	List of frequency, phase, amplitude, pulse, chirp, and modulation parameters such as Barker codes.
<b>Timing</b>	
<b>Uniform timer</b>	
Standard	Advance every 100 $\mu$ s to 34 s
Option SS1	Advance every 1 $\mu$ s to 34 s
Option SS4	Advance every 48 ns to 34 s
<b>Dwell timer</b>	
Standard	Advance every 100 $\mu$ s to 17 s
Option SS1	Advance every 1 $\mu$ s to 17 s
Option SS4	Advance every 48 ns to 17 s
<b>Number of points</b>	
Arbitrary list	1 to 500,000 per table assuming 50 sequences
	Lists and sequences share the same memory

1. Typically requires driving the PDWs via a compiled language program.

<b>Triggering</b>	
Point trigger	Auto, external, single, SCPI, timer, or trigger key
List trigger	Auto, external, single, SCPI, timer, or trigger key
Sequence trigger	Auto, external, single, SCPI, timer, or trigger key
<b>Markers</b>	
Marker types	List, sequence, point
Number of configurable markers	Up to 12, 8 simultaneously
Settable marker parameters	Polarity, delay

## Spectral purity

<b>Harmonics</b>	
Measured at +10 dBm or maximum specified power, whichever is lower. Performance is unspecified for harmonics beyond the specified frequency range.	
Fundamental frequency	Harmonic level
10 MHz to 2.61 GHz (Frequency Mode B)	-25 dBc (typ)
10 MHz to 1 GHz (Frequency Mode A)	-40 dBc
> 1 GHz to 2 GHz (Frequency Mode A)	-50 dBc
> 2 GHz (Frequency Mode A and B)	-55 dBc

<b>Sub-harmonics</b>			
Measured at +10 dBm or maximum specified power, whichever is lower. Sub-harmonics are defined as Carrier Freq *(x/N), where N indicates the frequency multiplication number and X is an integer value that is not an integer multiple of N. Does not apply to non-harmonic spurs which may overlap with sub-harmonics. Performance is unspecified for sub-harmonics beyond the specified frequency range.			
Fundamental frequency	1/2, 3/4, and 3/2 sub-harmonics	Other sub-harmonics	N
0.01 to < 1.43 GHz	None	None	1
1.43 to < 2.85 GHz	-75 dBc	-80 dBc	2
2.85 to < 5.7 GHz	-75 dBc	-80 dBc	4
5.7 to < 11.4 GHz	-75 dBc	-80 dBc	8
11.4 to < 16 GHz	-70 dBc	-80 dBc	16
16 to 20 GHz	-65 dBc (typ)	-70 dBc (typ)	16
> 20 to < 22.8 GHz (Opt 540)	-70 dBc (typ)	-70 dBc (typ)	16
22.8 to 38 GHz (Opt 540)	-70 dBc (typ)	-70 dBc (typ)	32
> 38 to 40 GHz (Opt 540)	-62 dBc (typ)	-70 dBc (typ)	32

<b>Non-harmonics</b>			
Measured in Frequency Mode A at +10 dBm or maximum specified power, whichever is lower. Performance is unspecified for non-harmonics beyond the specified frequency range.			
Fundamental frequency	Offsets > 300 Hz excluding Power-line related	Power-line related using external 10 MHz input	Power-line related using System Sync input
0.01 to < 1.43 GHz	-70 dBc (typ)	-60 dBc (typ)	-60 dBc
1.43 to < 2.85 GHz	-70 dBc (typ)	-60 dBc (typ)	-60 dBc
2.85 to < 5.7 GHz	-70 dBc (typ)	-50 dBc (typ)	-60 dBc
5.7 to < 11.4 GHz	-70 dBc (typ)	-50 dBc (typ)	-60 dBc
11.4 to < 18 GHz	-70 dBc (typ)	-50 dBc (typ)	-60 dBc
18 to 20 GHz	-70 dBc (typ)	-50 dBc (typ)	-60 dBc
> 20 GHz (Opt 540) <sup>1</sup>	-65 dBc (typ)	-45 dBc (typ)	-60 dBc

<b>Broadband noise</b>	
In CW mode at +10 dBm or maximum specified output power, whichever is lower, for offsets > 10 MHz.	
Frequency	Broadband noise
10 MHz to 20 GHz	-131 dBc/Hz (typ)
> 20 GHz to 40 GHz (Opt 540)	-125 dBc/Hz (typ)

1. At precisely 22 GHz, several spurs coalesce and may add to -60 dBc. Moving 1 Hz away from 22 GHz avoids this issue.

## Phase noise

Phase noise is measured using a CW signal at +10 dBm or maximum specified power, whichever is less, with spur optimizations off. Phase noise specifications exclude external mechanical vibration.

Absolute SSB phase noise (dBc/Hz)	
Frequency	Offset from carrier 20 kHz Spec (typ)
0.01 to < 1.43 GHz	-132 (-135)
1.43 to < 2.85 GHz	-125 (-129)
2.85 to < 5.7 GHz	-119 (-122)
5.7 to < 11.4 GHz	-114 (-117)
11.4 to 20 GHz	-109 (-112)
> 20 GHz (Opt 540)	-103 (-106)

  

Option EP1: Absolute SSB phase noise (dBc/Hz) for offsets $\leq$ 100 kHz						
Frequency	Offset from carrier					
	1 Hz Spec (typ)	10 Hz Spec (typ)	100 Hz Spec (typ)	1 kHz Spec (typ)	10 kHz Spec (typ)	100 kHz Spec (typ)
0.01 to < 1.43 GHz	-59 (-68)	-79 (-93)	-95 (-109)	-121 (-134)	-137 (-144)	-139 (-147)
1.43 to < 2.85 GHz	-53 (-63)	-76 (-86)	-88 (-101)	-114 (-127)	-129 (-136)	-134 (-141)
2.85 to < 5.7 GHz	-43 (-53)	-69 (-79)	-84 (-97)	-108 (-122)	-128 (-132)	-128 (-135)
5.7 to < 11.4 GHz	-37 (-49)	-63 (-73)	-78 (-90)	-101 (-114)	-121 (-126)	-122 (-130)
11.4 to 20 GHz	-33 (-44)	-58 (-68)	-69 (-84)	-96 (-110)	-114 (-120)	-117 (-125)
> 20 GHz (Opt 540)	-27 (-38)	-52 (-62)	-63 (-78)	-90 (-104)	-108 (-114)	-111 (-119)

Option EP1: Absolute SSB phase noise (dBc/Hz) for offsets $\geq$ 1 MHz			
Frequency	Offset from carrier		
	1 MHz Spec (typ)	10 MHz Spec (typ)	100 MHz Spec (typ)
10 to < 50 MHz	-145 (-151)	N/A	N/A
50 to < 500 MHz	-145 (-151)	-144 (-151)	N/A
0.5 to < 1.43 GHz	-145 (-151)	-144 (-151)	-137 (-147)
1.43 to < 2.85 GHz	-141 (-147)	-144 (-151)	-139 (-147)
2.85 to < 5.7 GHz	-137 (-143)	-139 (-145)	-134 (-142)
5.7 to < 11.4 GHz	-131 (-137)	-131 (-139)	-129 (-137)
11.4 to 20 GHz	-126 (-131)	-126 (-134)	-123 (-131)
> 20 GHz (Opt 540)	-120 (-125)	-120 (-128)	-117 (-125)





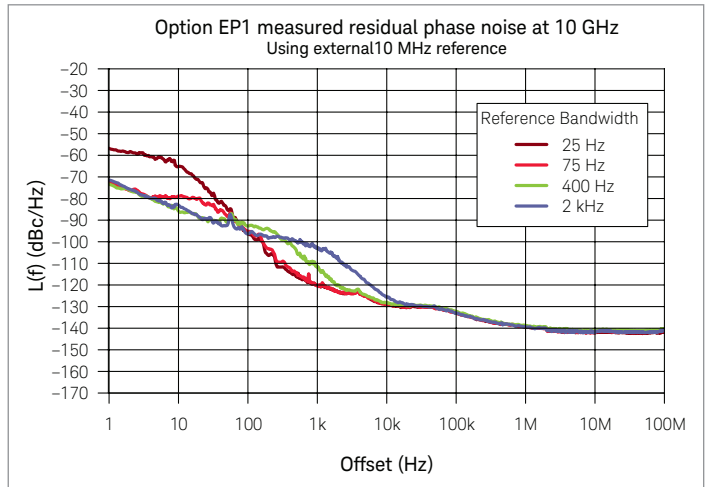
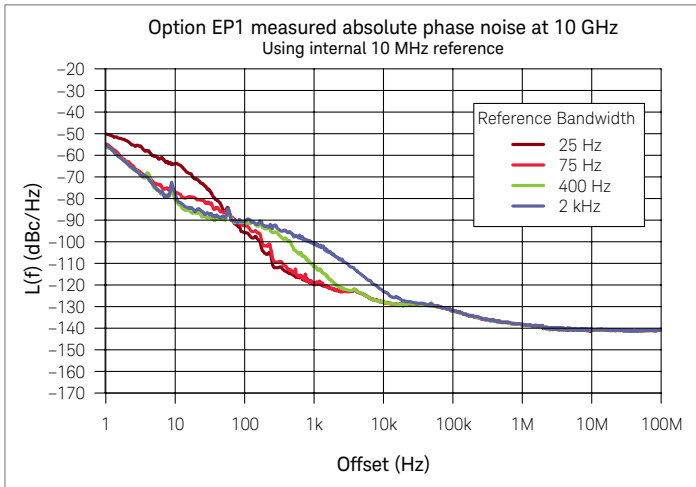
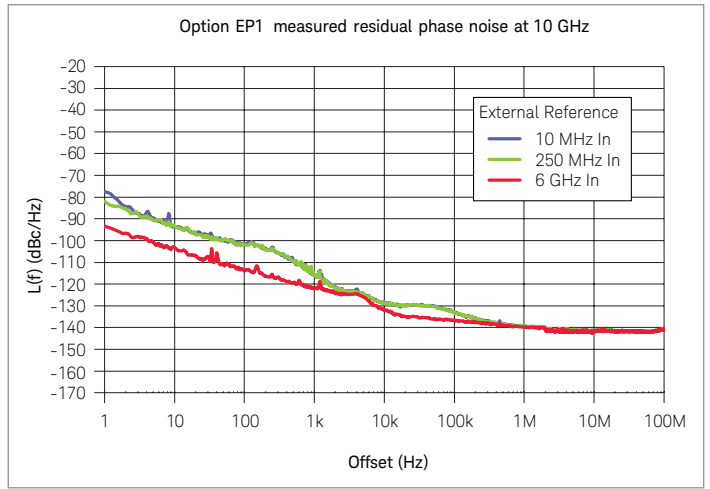
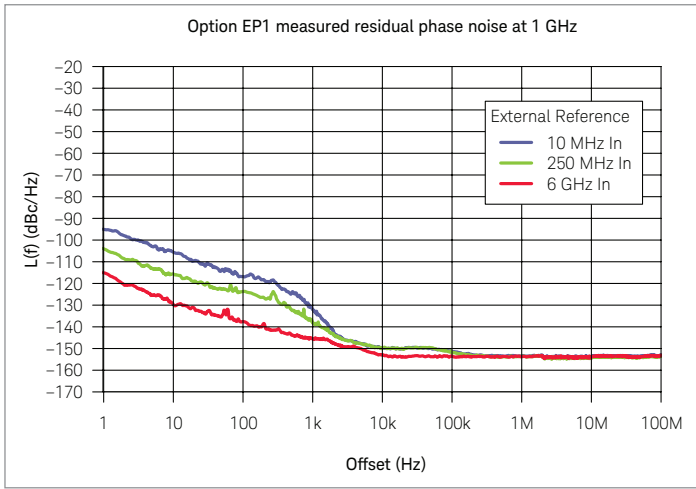
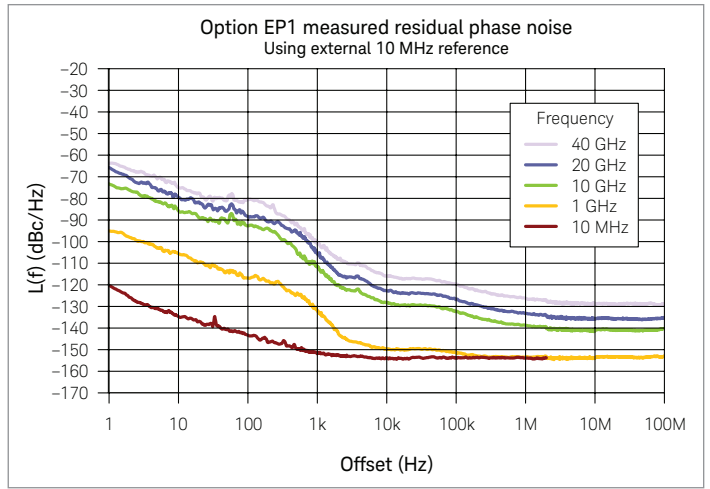
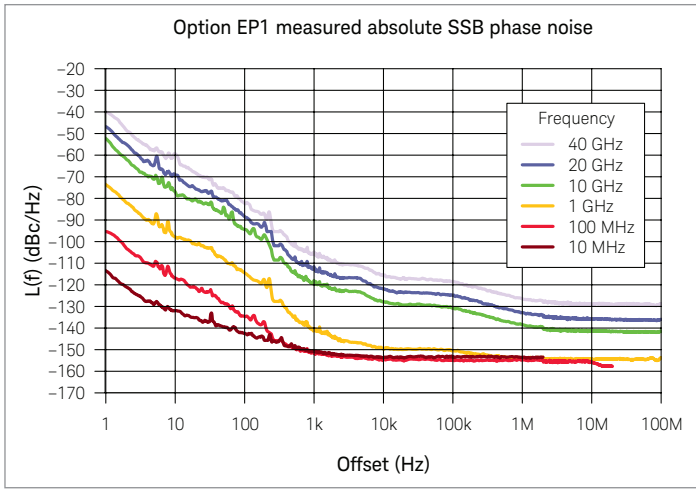

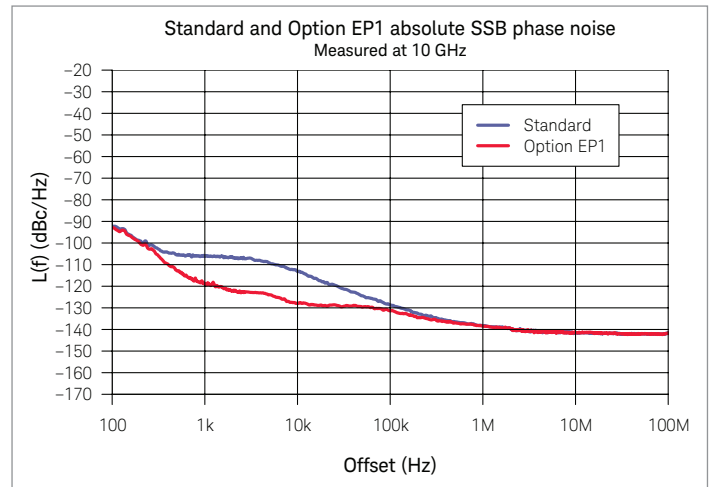
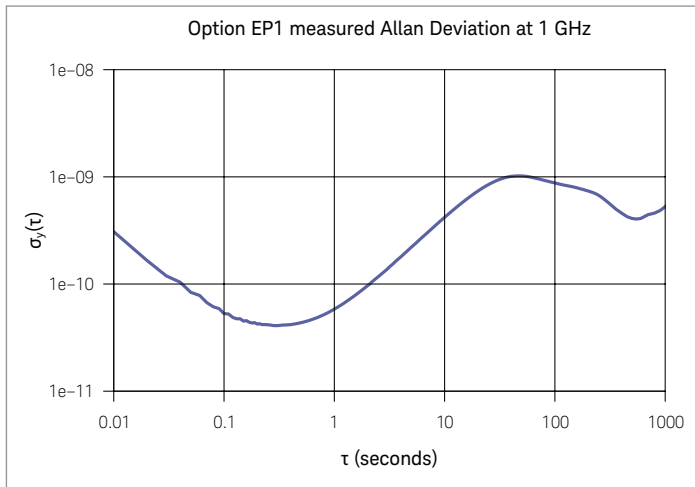
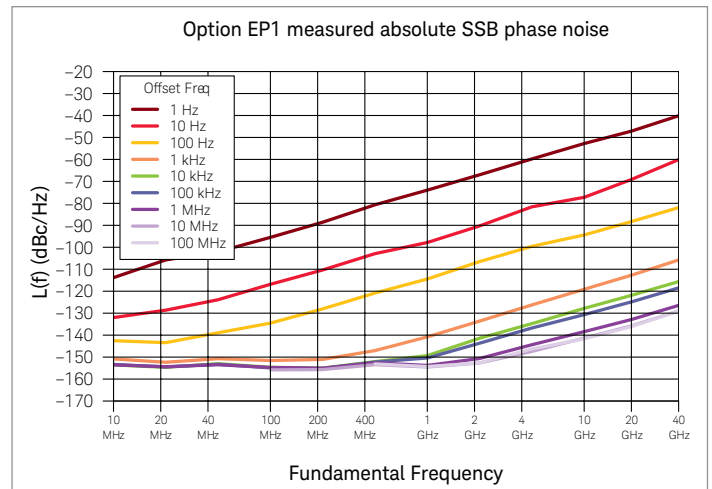
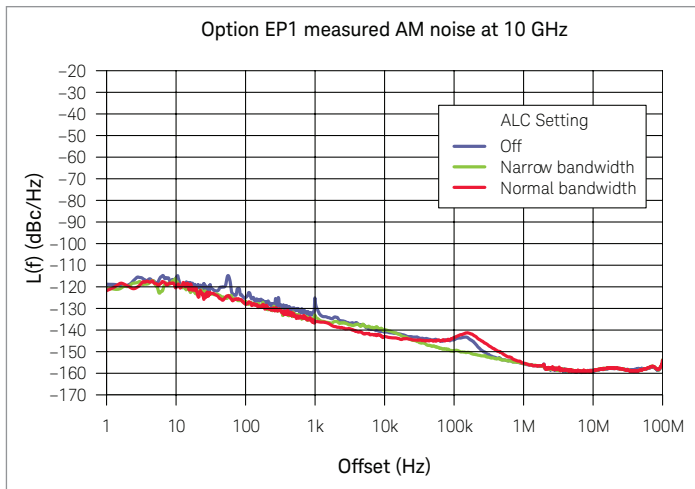
## Pulse modulation (Option PM1)

For frequencies from 400 MHz to 1.43 GHz, pulse modulation specifications apply in Mode B only. For frequencies below 400 MHz, pulse modulation is not specified.

Pulse types	
External input	The RF pulse width is the same as the input pulse width at the pulse/trigger gate input connector.
Triggered	The internal pulse generator is triggered by a selectable trigger source. The pulse delay and width are settable.
List mode	The pulse parameters are defined in a list.
Streaming mode	The pulse parameters are defined in the streamed PDW data.
Free run	The internal pulse generator generates pulses with the specified parameters without waiting for a trigger.
On/off ratio	
0.4 to < 4.2 GHz	80 dB (90 dB typ)
4.2 GHz to 20 GHz	90 dB
> 20 GHz (Option 540)	80 dB (90 dB typ)
Rise/fall times	
0.4 to < 1.43 GHz	(6 ns typ)
1.43 to < 2.85 GHz	10 ns (6 ns typ)
≥ 2.85 GHz	10 ns (3 ns typ)
Minimum pulse width	
ALC on	50 ns
ALC off	10 ns
Minimum pulse repetition interval	
ALC on	60 ns
ALC off	20 ns

### Time accuracy

Pulse start time accuracy/resolution 40 ps (typ)/10 ps

Pulse fine delay accuracy/resolution 40 ps (typ)/10 ps

### Level accuracy (relative to CW)

For pulse width  $\geq 100$  ns with ALC on and for pulse width  $\geq 10$  ns with ALC off.

0.4 to < 1.43 GHz  $\pm 1$  dB (typ)

$\geq 1.43$  GHz  $\pm 1$  dB (typ)

### Width compression

RF width relative to video out  $\pm 5$  ns (typ)

### Video feed-through

For frequencies  $\geq 400$  MHz and output power of 10 dBm or less 10% (typ)

### Video delay

External input to video output 60 ns (meas)

### RF delay (video to RF output)

Frequency > 500 MHz 10 ns (meas)

### Pulse overshoot

10% (typ)

### Input level

+1 V = RF on

0 V = RF off

### Input impedance

50  $\Omega$  (nom)

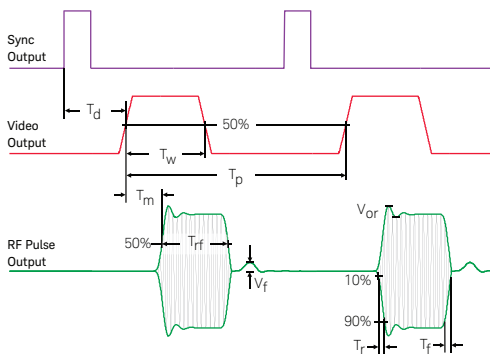

### Measured pulse shape

Frequency = 9 GHz, power = 10 dBm, amplitude = 10 dBm, ALC off, pulse width = 10 ns, pulse period = 100 ns. The oscilloscope is protected by a 10 dB pad and the timescale is set to 2 ns/div.

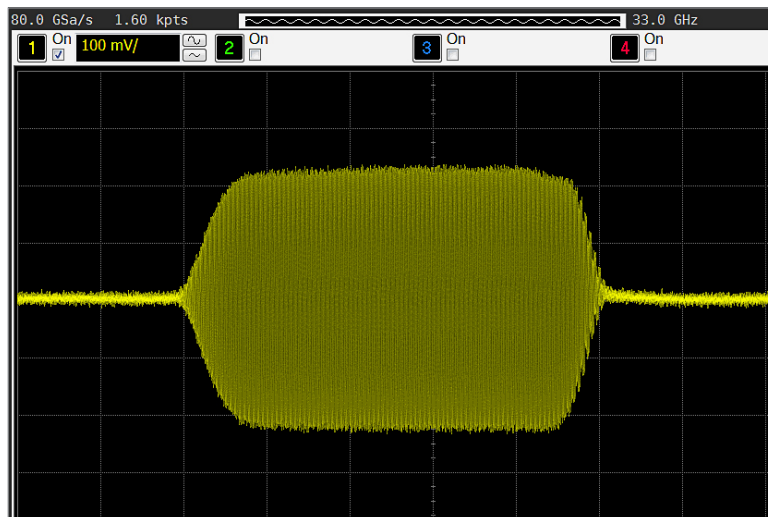

## Chirp and chirped-pulse modulation (Options UNT and PM1)

Option WC1 is required for chirp control through the Option CC1 I/O interface.

	FCP in normal mode		Streaming mode	Fast CW mode <sup>2</sup>	List mode
Options installed	Opt CC1 (LVDS) or Opt CC3/CC4 (10 Gbit Ethernet)	Opt CC2 (BCD)			
FMCW Chirp					
UNT	FMCW <sup>1</sup>	FMCW: 16 chirp slope selections	FMCW <sup>1</sup>	FMCW not available	FMCW <sup>1</sup>
Pulse Chirp					
UNT + PM1	LFM within pulse <sup>1</sup>	Chirped pulse not available	LFM within pulse <sup>1</sup>	Chirped pulse not available	LFM within pulse

Note: CW chirp (opt UNT required) and Pulse Chirp (opt PM1 required) are available under the Pulse/Chirp hardkey in all modes except Fast CW mode. Option WC1 is required for wideband modulation, including chirp.

1. Capability available with Firmware Revision A.01.70 with Option U03 or later.

2. When using the CC1 interface card for Fast CW switching, Option FR1 is required.

Pulse types	
Compatible without jitter	Free-run, synchronously triggered
With $\pm 8$ ns jitter	Asynchronously triggered
Incompatible	External pulse
Pulse and chirp alignment	
	Chirp start time is aligned to pulse start time within $\pm 50$ ns (typ)
Deviation (peak to peak) with Option UNT	
Option 520 cannot chirp beyond 21.5 GHz. Option 540 cannot chirp beyond 40 GHz.	
Frequency	Maximum peak to peak deviation
10 MHz to < 250 MHz	8 MHz
250 MHz to < 8 GHz	256 MHz
8 GHz to < 12 GHz	384 MHz
12 GHz to < 18 GHz	512 MHz
18 GHz to 20 GHz	768 MHz
> 20 GHz to < 26.5 GHz (Option 540)	768 MHz
$\geq 26.5$ GHz (Option 540)	1024 MHz
Deviation (peak to peak) with Options UNT and WC1	
Option 520 cannot chirp beyond 21.5 GHz. Option 540 cannot chirp beyond 40 GHz.	
Frequency	Maximum peak to peak deviation
50 MHz to 20 GHz	10% of center frequency
> 20 GHz (Option 540)	1.2 GHz
Wider deviations are available when not near a band edge, for example, any chirp which lies within one band is obtainable. See the frequency band diagrams. Amplitude accuracy may degrade for wide chirps.	
Rate	
Range	10 kHz/ $\mu$ s to 1.3 GHz/ns
Resolution	10 kHz/ $\mu$ s to 0.32768 kHz/ns depending on rate

## Internal pulse generator (Option PM1)

Internal pulse generator	
Modes	Free-run, square, and triggered
Square wave rate	0.1 Hz to 10 MHz with 0.1 Hz resolution (nom)
Pulse period (PRI) (Tp)	30 ns to 42 s, corresponding to repetition frequencies of 0.024 Hz to 33.33 MHz
Minimum pulse width (Tw)	4 ns (nom)
Pulse accuracy	40 ps (typ)
Delay resolution	10 ps
PRI resolution	2 ns
Width resolution	2 ns

## Frequency modulation (Option UNT)

Maximum rate	
Internal or external	10 MHz
Maximum peak deviation with Option UNT	
Option 520 cannot deviate beyond 21.5 GHz. Option 540 cannot deviate beyond 40 GHz.	
Frequency	Maximum peak deviation
10 MHz to < 250 MHz	4 MHz
250 MHz to < 8 GHz	128 MHz
8 GHz to < 12 GHz	192 MHz
12 GHz to < 18 GHz	256 MHz
18 GHz to 20 GHz	384 MHz
> 20 GHz to < 26.5 GHz (Option 540)	384 MHz
≥ 26.5 GHz (Option 540)	512 MHz
Maximum peak deviation with Options UNT and WC1	
Option 520 cannot deviate beyond 21.5 GHz. Option 540 cannot deviate beyond 40 GHz.	
Frequency	Maximum peak deviation
10 MHz to 20 GHz	5% of center frequency
> 20 GHz (Option 540)	600 MHz
Wider deviations are available when not near a band edge, for example, any FM deviation which lies within one band is obtainable. See the frequency band diagrams. Amplitude accuracy may degrade for wide FM.	
Resolution	
0.1% of deviation or 1 Hz, whichever is greater	
Deviation accuracy	
Measured at a 1 kHz rate with 100 kHz deviation.	
Internal	± 1% of FM deviation (± 0.2% typ)
External In	± 3.5% of FM deviation + 20 Hz
Modulation frequency response (3 dB bandwidth)	
Measured at 100 kHz deviation.	
DC coupling	DC to 10 MHz (nom)
AC coupling	5 Hz to 10 MHz (nom)
External DC FM carrier offset	
At the calibrated deviation and carrier frequency, within 5 °C of ambient temperature at time of user calibration.	
± 0.1% of set deviation (meas)	
Distortion	
Measured at a 1 kHz rate with 100 kHz deviation.	
0.4%	
Sensitivity	
± 1 V <sub>peak</sub> for indicated deviation	
Frequency coding (FSK)	
Number of levels	16 levels, at least 32 maps
Minimum bin width	4 ns
Maximum pattern length	65,536 bits/pattern

## Phase modulation (Option UNT)

<b>Maximum rate</b>	
Internal or external	10 MHz
<b>Maximum peak deviation in radians</b>	
$\frac{5\% \text{ of carrier frequency}}{\text{modulation frequency}}$ or $\frac{600 \text{ MHz}}{\text{modulation frequency}}$ or $12\pi$ whichever is less	
<b>Resolution</b>	
0.1% of set deviation	
<b>Deviation accuracy</b>	
Measured at a 1 kHz rate with $3\pi$ rad deviation.	
Internal	$\pm 1\%$ of $\Phi$ M deviation ( $\pm 0.2\%$ typ)
External In	$\pm 3.5\%$ of $\Phi$ M deviation
<b>Modulation frequency response (3 dB bandwidth)</b>	
Measured at $3\pi$ rad deviation	
DC coupling	DC to 10 MHz (nom)
AC coupling	5 Hz to 10 MHz (nom)
<b>Distortion</b>	
Measured at a 1 kHz rate with $3\pi$ rad deviation	
Total harmonic distortion	0.5% (0.1% typ)
<b>Sensitivity</b>	
$\pm 1 V_{\text{peak}}$ for indicated deviation	
<b>Phase modulation types</b>	
Triggered BPSK	Phase can be changed $180^\circ$ on a bin-by-bin basis every 8 ns via an external trigger
<b>Barker coding</b>	
Supported codes	2, 3, 4, 5, 7, 11, 13
<b>Phase coding (PSK)</b>	
Number of levels	16 levels, at least 32 maps
Minimum bin width/resolution	4 ns / 4 ns
Maximum pattern length	65,536 bits/pattern

## Amplitude modulation (Option UNT)

AM performance is typical up to 20 GHz with ALC on when AM peaks do not exceed maximum specified power. AM performance is not specified with ALC off or above 20 GHz or when AM peaks exceed maximum specified power.

<b>Maximum depth</b>	
80% (14 dB)	
<b>Depth accuracy</b>	
ALC on, 1 kHz rate and depth $\leq 80\%$	$\pm (6\% \text{ of setting} + 1\%)$
<b>External input (selectable polarity)</b>	
Sensitivity for indicated depth	$1 V_{\text{peak}}$
Maximum voltage	$\pm 1 \text{ V}$
<b>Modulation frequency response (3 dB bandwidth) <sup>1</sup></b>	
Measured at 30% depth	
DC coupling	DC to 10 MHz (nom)
AC coupling	5 Hz to 10 MHz (nom)
<b>Distortion</b>	
30% AM, 1 kHz rate	1.5% total harmonic distortion
60% AM, 1 kHz rate	2% total harmonic distortion

1. Units without an option AT2 attenuator will have degraded performance.

## External modulation inputs (Option UNT)

Connections	Ext1 and Ext2
Modulation types	AM, FM, and $\Phi$ M
Input impedance	50 $\Omega$ , 600 $\Omega$ , or 1 M $\Omega$ (nom) switched

## Internal modulation source (Option UNT)

Dual function generators	Provide two independent signals (internal1 and internal2) for use with AM, FM, $\Phi$ M, or LF output
Waveforms	Sine, square, positive ramp, negative ramp, triangle, pulse, uniform noise, Gaussian noise
<b>Rate range</b>	
Sine	0.1 Hz to 10 MHz
Square, ramp, triangle	0.1 Hz to 1 MHz
Resolution	0.1 Hz
Accuracy	Same as timebase
<b>LF output</b>	
Output	Internal 1, internal 2, noise generator 1, noise generator 2 Also provides monitoring of function generators when used for AM, FM, or $\Phi$ M
Amplitude	0 to 5 V <sub>peak</sub> (nom) into 50 $\Omega$ or 10 V (nom) into 1 M $\Omega$
Output impedance	50 $\Omega$ (nom)

## Simultaneous modulation

<b>Simultaneous modulation</b>
All modulation types (FM, AM, $\Phi$ M, chirp, and pulse modulation) may be simultaneously enabled except FM with $\Phi$ M.
AM, FM, and $\Phi$ M can sum simultaneous inputs from any two sources (Ext1, Ext2, internal1, or internal2).
Any given source (Ext1, Ext2, internal1, or internal2) may be routed to only one activated modulation type.

## Remote programming

Interfaces	GPIB (IEEE-488.2,1987) with listen and talk, USB 2.0, and 1000BaseT LAN interface.
Control languages	SCPI version 1997.0. Code compatibility modes for Aeroflex 2500, 2200, FS2000 or FS5000.
IEEE-488 functions	SH1, AH1, T6, TE0, L4, LE0, SR1, RL1, PPO, DC1, DTO, C0, E2
Keysight IO libraries	Keysight's IO Library Suite helps you quickly establish an error-free connection between your PC and instruments, regardless of the vendor. It provides robust instrument control and works with the software development environment you choose.

## General specifications

Power requirements	100/120 VAC 50/60/400 Hz or 220/240 VAC 50/60 Hz (automatically selected) < 350 W typical, 400 W maximum
Operating temperature range	0 to 55 °C
Storage temperature range	-40 to 70 °C; during storage below -20 °C, instrument states may be lost
Altitude	0 to 4600 m (15,000 ft)
Humidity	Maximum relative humidity (non-condensing): 95%RH up to 40 °C, decreases linearly to 45%RH at 55 °C <sup>2</sup>
Environmental testing	Samples of this product have been tested in accordance with the Keysight Environmental Test Manual and verified to be robust against the environmental stresses of storage, transportation, and end-use. Those stresses include but are not limited to temperature, humidity, shock, vibration, altitude, and power line conditions. Test methods are aligned with IEC 60068-2 and levels are similar to MIL-PRF-28800F Class 3. Phase noise specifications are not warranted in a vibrating environment.
ISO compliant	This family of signal generators is manufactured in an ISO-9001 registered facility in concurrence with Keysight's commitment to quality.
EMC	Conforms to the immunity and emission requirements of IEC/EN 61326-1 including the conducted and radiated emission requirements of CISPR Pub 11/2009 Group 1, Class A.
Acoustic noise	Normal: 48 dBA (nom) Worst case: 68 dBA (nom)
Storage	Memory is shared by instrument states and sweep list files. The solid-state drive initially has at least 512 GB of free space <sup>1</sup> .
Security	Display blanking Memory clearing functions (See Application Note, "Security Features of Keysight Technologies Signal Generators," Part Number E4400-90621). Removable Solid State Drive (SSD) with all user data.
Self-test	Internal diagnostic routine tests most modules in a preset condition. If node voltages are within acceptable limits, then the module passes the test.
Weight	< 25 kg (54 lb.) net < 34 kg (73 lb.) shipping
Dimensions	134 mm H x 426 mm W x 559 mm D (5.25" H x 16.8" W x 22.0" D)
Recommended calibration cycle	12 months

1. Instruments with s/n 53310101 to 58039999 (shipped prior to March 9, 2018) have 480 GB capacity.

2. From 40 °C to 55 °C, the maximum % Relative Humidity follows the line of constant dew point.



# Input/Output Descriptions

## Front panel connectors

Unless otherwise noted, all connectors are BNC female, digital inputs and outputs are 3.3 V CMOS, and digital inputs will accept 5 V CMOS, 3 V CMOS, or TTL voltage levels. Option 1EM moves all connectors to the rear panel except the USB connectors.

RF output	Output impedance 50 $\Omega$ (nom)
Option 520	Standard: Precision APC-3.5 male; plus 3.5 to 3.5 mm female adapter Option 1ED: Type-N female; plus Type-N male to SMA female adapter
Option 540	Precision 2.4 mm male; plus 2.4 to 2.4 mm and 2.4 to 2.9 mm female adapters.
USB 2.0 primary (2 ports)	Allows control of USB devices. USB Type-A female connector. Nominal output current 0.5 A.
LF output	Outputs the internally generated LF source. Nominal output impedance 50 $\Omega$ .
External input 1	Drives either AM, FM, or $\Phi$ M. Nominal input impedance is 50 $\Omega$ , 600 $\Omega$ , or 1 M $\Omega$ , selectable. Damage levels are 5 V <sub>rms</sub> and 10 V <sub>peak</sub> .
External input 2	Drives either AM, FM, or $\Phi$ M. Nominal input impedance is 50 $\Omega$ , 600 $\Omega$ , or 1 M $\Omega$ , selectable. Damage levels are 5 V <sub>rms</sub> and 10 V <sub>peak</sub> .
Pulse/trigger gate input	Accepts input signal for external pulse modulation. Also accepts external trigger pulse input for internal pulse modulation. Nominal impedance 50 $\Omega$ . Damage levels are 5 V <sub>rms</sub> and 10 V <sub>peak</sub> .
Pulse video out	Outputs a signal that follows the RF output for internal pulse modes. TTL-level compatible. Nominal source impedance 50 $\Omega$ .
Pulse sync out	Outputs a synchronizing pulse, nominally 50 ns width, for internal pulse modes. TTL-level compatible, nominal source impedance 50 $\Omega$ .

## Rear panel connectors

Unless otherwise noted, all connectors are BNC female, digital inputs and outputs are 3.3 V CMOS, and digital inputs will accept 5 V CMOS, 3 V CMOS, or TTL voltage levels. Option 1EM moves the front panel connectors to the rear panel except the USB connectors.

GPIB	Operates as a GPIB controller or device. IEEE-488 bus connector.
LAN (1000 BaseT)	Allows LAN TCP/IP communication. RJ45 Ethertwist connector. The LAN connector provides the same SCPI remote programming functionality as the GPIB connector. The LAN connector is used to access the internal web server and FTP server. The LAN supports DHCP, HiSLIP, sockets SCPI, VXI-11 SCPI, connection monitoring, dynamic hostname services, and TCP keep alive. This interface is LXI class C compliant.
USB 2.0 primary (2 ports)	Allows control of USB devices. USB Type-A female connector. Nominal output current 0.5 A.
USB 2.0 secondary (1 port)	Receives control from USB host. USB Type-B female connector. Nominal output current 0.5 A.
PCIe x8	Provides 8 lanes of PCIe I/O. Reserved for future use.
10 MHz input	Accepts a 10 MHz external reference (timebase) input. Nominal input impedance 50 $\Omega$ . Nominal input range 0 to 12 dBm.
10/100 MHz output	Provides a reference signal of 10 MHz or 100 MHz, selectable. Nominal output impedance 50 $\Omega$ . Output power is +7 dBm nominal. Suitable for use with the 10 MHz input or System Sync input of another compatible signal generator.
10 MHz EFC	Accepts an external DC voltage, ranging from -10 V to +10 V, for electronic frequency control (EFC) of the internal 10 MHz reference oscillator. This voltage inversely tunes the oscillator about its center frequency. See the EFC sensitivity in the frequency section. The nominal input impedance is greater than 1 M $\Omega$ .
System sync input	Accepts an external reference input. The acceptable frequencies are listed in the synchronization section. Nominal input impedance 50 $\Omega$ , with a DC block. Nominal input range 0 to 12 dBm.
RF sync output	Provides an external reference output of 10, 100, or 250 MHz, or Sync Output, selectable. Nominal output impedance 50 $\Omega$ . Nominal output power 12 dBm. Suitable for use with the System sync input. This output is a square wave with a fast rise time. To avoid electromagnetic interference, use coaxial cable with at least 90 dB shielding effectiveness. Example: Times Microwave Systems LMR 240 coaxial cable used in Amphenol PN 115101-22-48.00 BNC cable assembly. Output power is +11 dBm nominal.
6 GHz input	SMA female connector. Accepts a synchronization input of 6 GHz. Nominal input impedance 50 $\Omega$ . Nominal input range 5 to 17 dBm. Damage levels are above +23 dBm.
6 GHz output	SMA female connector. Provides a synchronization output of 6 GHz. Nominal output impedance 50 $\Omega$ . Output power is +15 dBm nominal. Suitable for use with the 6 GHz input.
Triggers 1-14	Number of trigger varies depending on which option is installed (CC1, CC2, CC#, or CC4). These use 3.3V CMOS levels and are tolerant to 5V inputs. The output impedance is 50 $\Omega$ and the input is high impedance.

## Fast Control Port (FCP) interface modules

On the trigger and marker connectors, digital inputs and outputs are 3.3 V CMOS, and digital inputs will accept 5 V CMOS, 3 V CMOS, or TTL voltage levels.

Option CC1 I/O interface	
Data port	100 pin LVDS
Triggers and markers	2 SMA <sub>(f)</sub> and 12 SMB <sub>(m)</sub>
Data format	Binary
Controllable parameters	Frequency, amplitude, phase, phase coding, band, pulse, chirp, FM deviation, $\Phi$ M deviation, depending on installed options
Option CC2 I/O interface	
Data connector	50 pin
Triggers and markers	2 SMA <sub>(f)</sub>
Data format	Binary coded decimal (BCD)
Controllable parameters	Frequency, FM deviation, or 16 Chirp rates
Option CC4 I/O interface	
Data ports	2 SFP+ transceivers
Triggers and markers	2 SMA <sub>(f)</sub> bidirectional and 12 SMB <sub>(m)</sub> (7 bidirectional plus 5 duplicate output-only ports)
Data format	Keysight data streaming protocol (KDSP)
Controllable parameters	Frequency, amplitude, phase, phase coding, band, pulse, chirp, FM deviation, $\Phi$ M deviation, depending on installed options

## Rear panel of N5193A

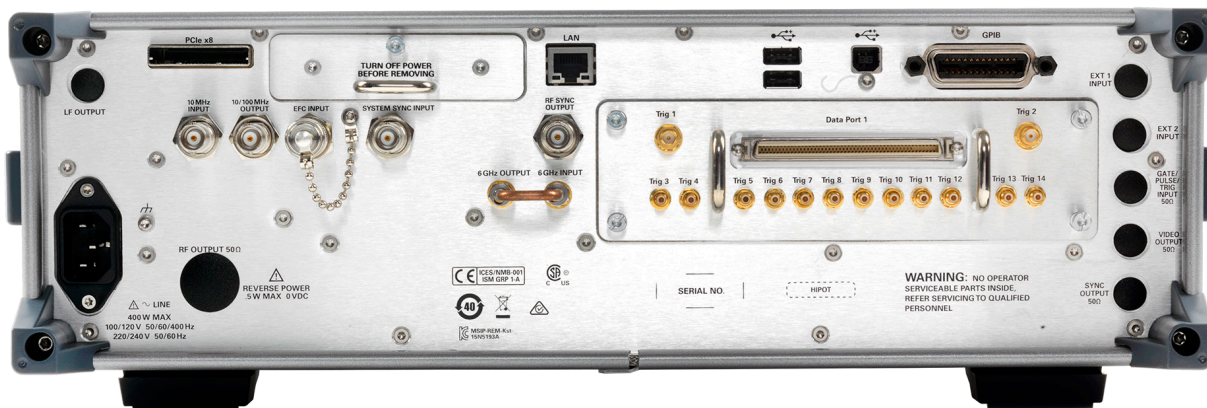

## Performance Archive

From time to time, Keysight Technologies may make changes to instrument performance. Details on the specifications and performance differences of earlier versions summarized below can be found in the N5193A data sheet archive found in the UXG online documentation at <http://www.keysight.com/main/editorial.jsp?cc=US&lc=eng&ckey=2550695&nid=-32491.1150339.00&id=2550695>.

Solid state drive (SSD) capacity was increased from 80 GB to 480 GB on instruments with s/n  $\geq$  53310101, shipped after July 30, 2015. SSD capacity was again increased from 480 to 512 GB on instruments with s/n  $\geq$  5804xxxx, shipped after March 9, 2018.

Option AT2 replaced the previous attenuator option AT1 on instruments with s/n  $\geq$  5646xxxx. Option AT2 offers improved performance in the 25.6 to 40 GHz range. Option AT1 performance specifications can be found on pages 7 to 10 in the N5193A data sheet dated June 8, 2016.

Option SS4 replaced the previous switching speed option SS2 on instruments with s/n  $\geq$  5646xxxx. Option SS4 offers improved performance for Type 4 frequency transitions. Option SS4 performance specifications can be found on page 11 in the N5193A data sheet dated June 8, 2016.

Option CC4 replaced the previous option CC3 10 GB Ethernet I/O card. Option CC4 is a form/fit/functional replacement for CC3 and offers additional triggering ports.

Option U01 added support for triggered BPSK with firmware version A.01.40.

Option U02 added support for CW Chirp with firmware revision A.01.60.

Option U03 enabled narrowband chirps in List, FCP, and Streaming mode without requiring options WC1 or WC2 for full frequency range with firmware revision A.01.70.

Option U04 added the ability to play non-linear chirps (MESG waveforms only) and increased Chirp Rate resolution when using CC1 rear-panel board with firmware revision A.01.75.

The latest Uxx option can be obtained by ordering N5193AU Option R2C.

## Related Literature

Publication title	Publication number
<i>N5193A UXG Agile Signal Generator - Brochure</i>	5992-0091EN
<i>N5193A and N5191A Agile Signal Generator - Configuration Guide</i>	5992-1116EN

Learn more at: [www.keysight.com](http://www.keysight.com)

For more information on Keysight Technologies' products, applications or services, please contact your local Keysight office. The complete list is available at: [www.keysight.com/find/contactus](http://www.keysight.com/find/contactus)

