

R&S®ZNA

Vector Network Analyzer

Masters the most challenging measurement tasks





Contents

Overview

R&S® ZNA Vector Network Analyzer

▷ page 4

State-of-the-art user interface

▷ page 6

Rear panel connections

▷ page 8

Highlights

Unique operating concept with two touchscreens

▷ page 10

Top-class hardware components

▷ page 13

Hardware options

▷ page 14

Unprecedented RF quality

▷ page 16

The right calibration for every test scenario

▷ page 17

Applications

Compression point measurements

▷ page 21

Intermodulation measurements on amplifiers and mixers

▷ page 22

Pulsed measurements – fast and simple

▷ page 24

Mixer measurements easier than ever

▷ page 26

Spectrum analysis with multichannel view

▷ page 28

Antenna measurements – the perfect fit

▷ page 29

Millimeterwave measurements

▷ page 30

Time domain analysis and signal integrity measurements

▷ page 32

R&S®ZNA

Vector Network Analyzer

At a glance

Offering outstanding RF characteristics and a unique hardware architecture, the R&S®ZNA high-end vector network analyzer makes demanding measurements easier than ever. Another feature new to the market is the analyzer's DUT-centric operating concept, which guides users quickly and conveniently to the desired measurement setup. Two independent touchscreens provide utmost flexibility for smooth, efficient operation.

The R&S®ZNA features exceptional stability, low trace noise and excellent raw data, making it a perfect choice for development and production applications that require high accuracy, e.g. for developing and producing components and modules for A&D and satellite applications.

The R&S®ZNA offers four internal, phase-coherent sources, allowing independent control of the signal's frequency at each port as well as phase measurements on mixers. It provides two internal local oscillators (LOs), a true multi-channel receiver architecture, pulse modulators and comprehensive trigger and synchronization capabilities. These hardware features make the R&S®ZNA a universal, compact test system for active and passive device characterization. Even intermodulation measurements on mixers and receivers can be performed without external signal generators, minimizing test time and simplifying test configuration.

Thanks to the phase-coherent digital sources and receivers, no reference mixers are needed for mixer phase measurements, and test setups are configured just as easily as for non-frequency-converting S-parameter measurements.

Users can operate the R&S®ZNA via two independent touchscreens.

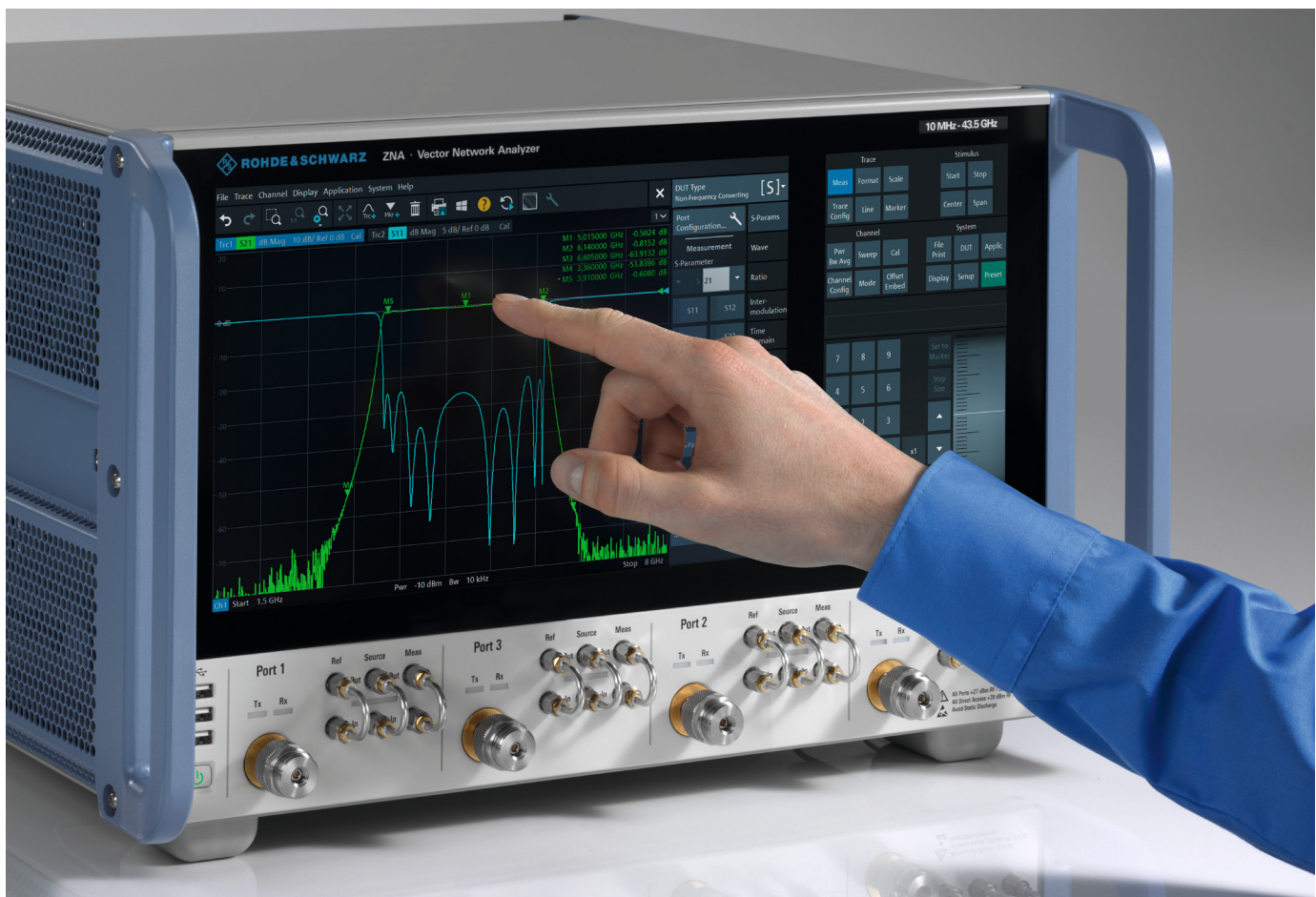

The analyzer's DUT-centric operating concept makes it possible to achieve the desired setup at an unrivaled speed. Users no longer need to laboriously work through a jungle of menus. Instead, a wizard guides them step by step through configuration and calibration. All relevant parameters are covered, and measurement traces are created in just a few steps.

The R&S®ZNA characterizes low-noise amplifiers (LNA), receivers, frequency-converting DUTs and T/R modules precisely and efficiently; the DUT needs to be connected only once.

The instrument provides numerous software applications, e.g. for intuitive configuration of group delay and spectrum measurements.

Key facts and benefits

Four internal phase-coherent sources

- ▮ Compact multiple source setups
- ▮ Convenient phase measurements on mixers

Two internal LOs for the receivers

- ▮ Fast mixer measurements
- ▮ More accurate phase results due to simultaneous sampling of signals

Eight truly parallel measurement receivers

- ▮ Measurements on multipath DUTs and antenna arrays, use of analyzer as powerful core in antenna test systems

Four internal pulse modulators

- ▮ Two-tone and bidirectional pulsed signal measurements

Phase measurements on mixers without reference mixers

- ▮ Simple mixer tests in a compact setup

Spectrum analysis option

- ▮ DUT characterization and spurious search without reconnecting the DUT to a spectrum analyzer

Group delay measurements on frequency converters with embedded LOs

- ▮ Reliable, straightforward satellite receiver measurements

High dynamic range: 139 dB (typ.), up to 170 dB (typ.) with options

- ▮ Characterization of high-rejection filters
- ▮ Short test times and low trace noise

Wide power sweep range of 100 dB (typ.)

- ▮ Versatile compression measurements

Low trace noise of < 0.001 dB (at 1 kHz IF bandwidth)

- ▮ Accurate, highly reproducible measurements

DUT-centric operating concept

- ▮ Easy startup, short configuration times

Compact instrument, quiet operation: acoustic noise as low as 42 dB(A)

- ▮ Small footprint, low noise pollution

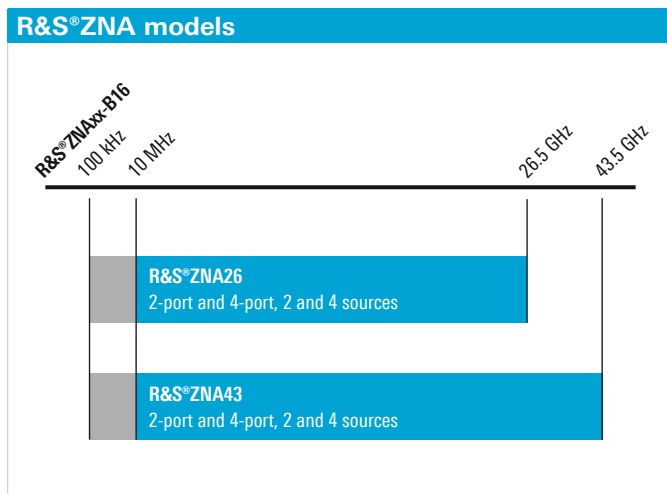

State-of-the-art user interface

Menu bar

For operation with a mouse or finger

Context-sensitive help

Undo/Redo

Cancels or restores the last operations

Toolbar

Frequently used functions such as zoom, new trace, new marker, print

More than 100 channels and traces

- Straightforward display of complex measurements
- Simultaneous, independent display of multiple test setups; display of large number of traces; arrangement of traces, channels and diagrams in any desired combination

Three front panel USB ports for connecting

- Storage media
- Keyboard and mouse
- Calibration units
- Power sensors

Status LEDs for test ports indicating

- TX/RX operation
- Input active



12.1" touchscreen with state-of-the-art GUI

Softkeys and soft panel

- Logically structured menus: everything in view without scroll bar
- All parameters for a test setup presented in straightforward GUI dialogs
- Measured traces can be dragged and dropped

Touch panel

Instrument control and display of macros

Soft roll key with locking function

Status LEDs

Calibration status, remote operation, etc.



Direct source and receiver access

Rear panel connections

Display ports

- DisplayPort
- DVI-D

LAN port

SSD (removable)

Trigger board option

- Three additional trigger inputs
- Four trigger outputs
- Four connectors for pulse modulator control
- Ready for trigger (output)
- Busy (output)
- RF interlock control (input)

GPIO port

Standard control and sync connectors

- Reference frequency output: 10 MHz, 100 MHz
- Reference frequency input:
1 MHz to 50 MHz, 100 MHz, 1 GHz
- Trigger input



USB control

For remote device control via USB

Modular design for easy maintenance

Control PC and power supply

Four USB ports (2.0/3.0) for connecting

- ▮ Storage media
- ▮ Keyboard and mouse
- ▮ Calibration units
- ▮ Power sensors

User port

- ▮ Digital I/Os
- ▮ Power supply

Direct IF access

- ▮ I/Os (input/output switchable), 2 GHz IF bandwidth
- ▮ Access to measurement and reference receiver of each port

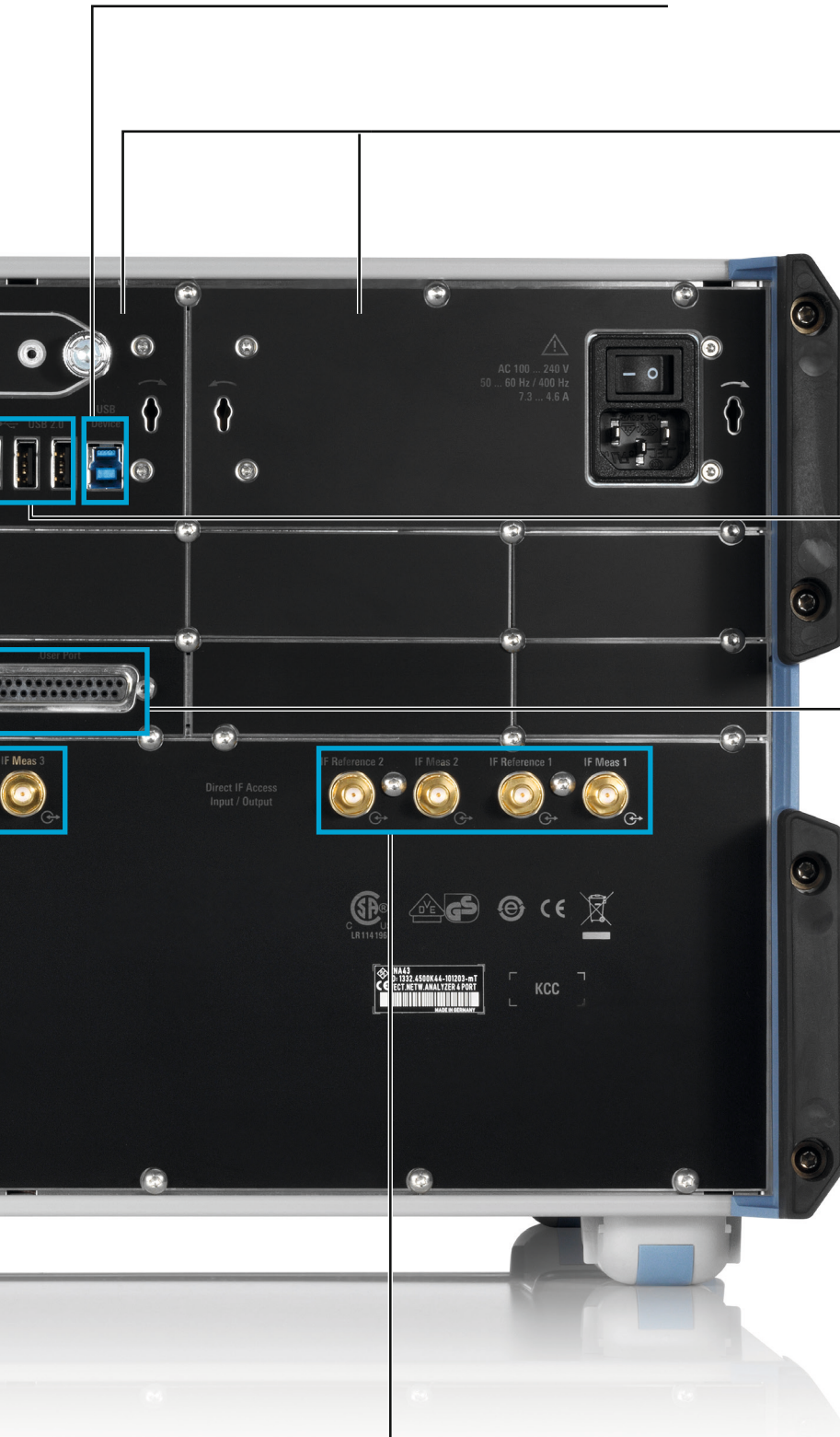

Unique operating concept with two touchscreens

Operation using touch gestures

Users can operate the R&S®ZNA via two independent touchscreens:

- Innovative control panel on the right instead of mechanical keys which can wear out over time
- 12.1" touch display on the left shows measured traces

The dual-screen operating concept offers utmost flexibility in configuring measurements. Touch gestures are used to zoom, move traces and add markers.

Traces, channels and diagrams can be dragged and dropped to arrange them in any desired combination. The control panel on the right can, among other things, be used to display macros, remote control commands and auxiliary tools.

Analyzer operation is intuitive, which significantly shortens the learning curve and delivers results very quickly.

Trace analysis functions

A wide variety of trace analysis functions provide a clear overview of key parameters:

- Ten markers per trace, including analysis functions and conversion to desired unit
- Automatic bandwidth measurement on filters
- Limit and ripple check with configurable pass/fail indication
- Statistical trace analysis including maximum, minimum, RMS, peak-to-peak and compression point
- Equation editor for complex trace mathematics

Users can configure measurement tasks conveniently with touch gestures.

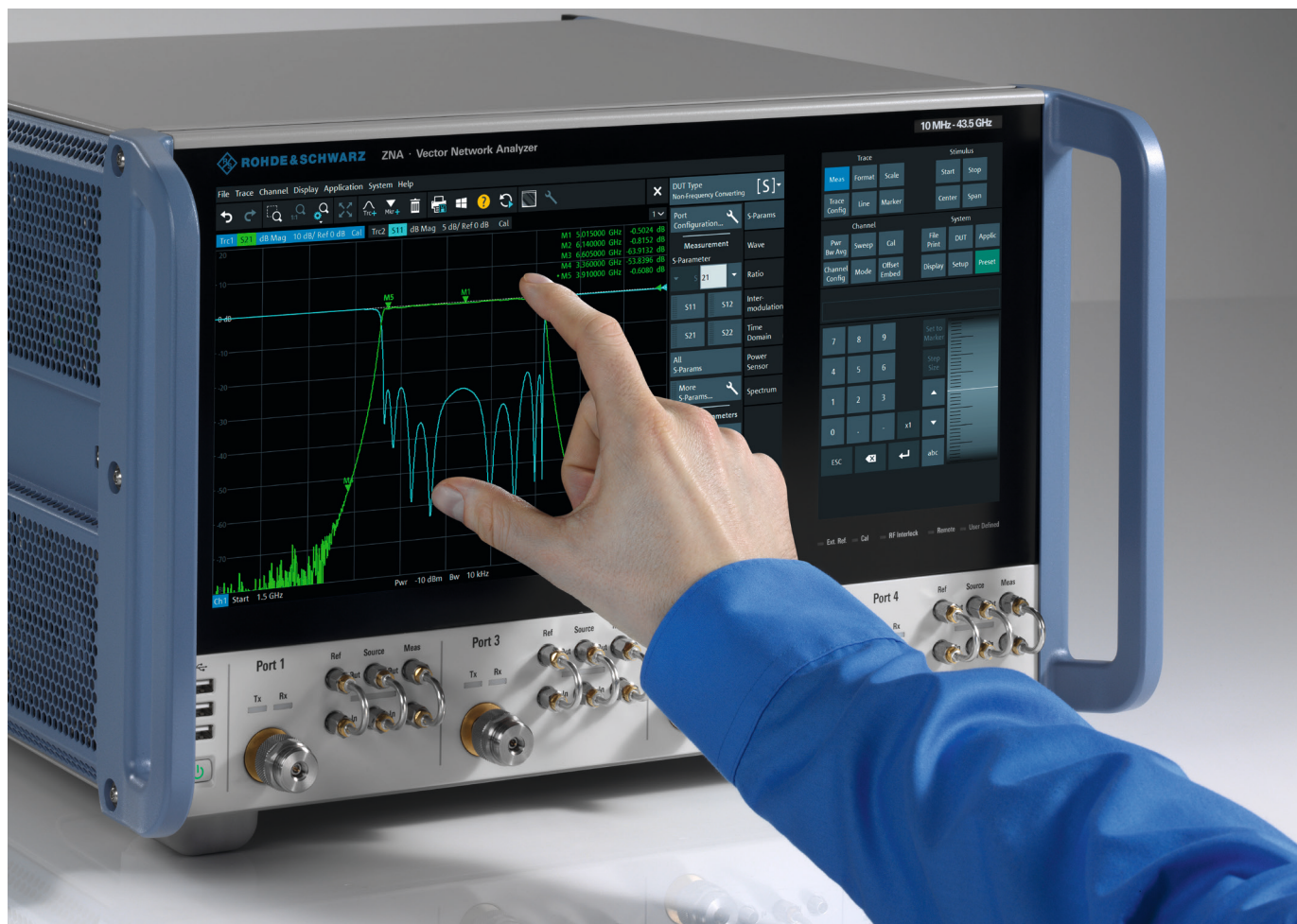

Zoom function



Users can zoom with a simple finger gesture or by dragging the mouse.
The background color of the screen can be configured as desired.

Control of the R&S®ZNA via touch panel



Fast switching between instrument setups

With the R&S®ZNA, multiple setups can be kept in memory simultaneously, allowing the user to switch quickly between measurement tasks. This feature is especially advantageous with DUTs that deliver a variety of complex measurement results, as it provides a quick overview and simplifies operation.

User-friendly thanks to DUT-centric approach

In addition to classic parameterization, where the user configures individual measurement quantities, the R&S®ZNA also supports a DUT-centric approach for configuring measurements.

In DUT-centric mode, the user first selects the DUT type, e.g. amplifier or mixer. The instrument will then prompt the user, in a step-by-step process, to select and configure the desired measurements (such as gain, compression point, intercept point, isolation). There is no more tedious searching through diverse menus. When configuration is completed, the instrument creates the required channels and measurement traces, and is then ready for calibration and for performing the required measurements.

Thanks to the instrument's straightforward menu structures, the R&S®ZNA is also intuitive to operate for users who do not take the DUT-centric approach. Users can configure measurements in just a few, logical steps, requiring typically half of the time needed with conventional menu structures.

DUT-centric measurement configuration

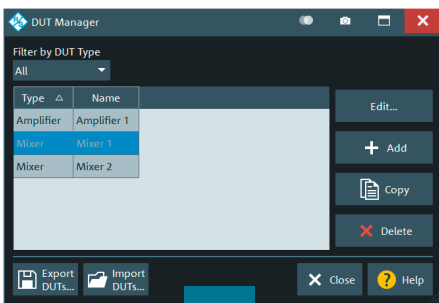

Based on the DUT type, the user is prompted to select and configure the desired measurements in a step-by-step process. The required channels and traces, e.g. for measuring LO feedthrough, are automatically created.

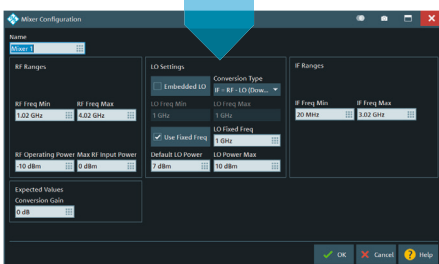

Top-class hardware components

The R&S®ZNA comes with an extensive range of hardware options, allowing customized configuration for the intended use.

Four internal sources

The R&S®ZNA is available with up to four internal sources. The user benefits from a powerful, compact system that can even perform intermodulation measurements on mixers and receivers with two converter stages. The digitally controlled, phase-coherent and phase-repeatable sources allow phase measurements on mixers and converters without external reference mixers.

Direct IF access

When used as inputs, the R&S®ZNA-B26 ports provide direct access to the internal IF signal paths (with selectable IF frequencies), allowing the analyzer to be used in antenna test systems. When used as outputs, the ports make it possible to record and analyze data using external equipment.

Synchronization and trigger capabilities

The R&S®ZNA offers a comprehensive range of synchronization and trigger features such as diverse trigger inputs and outputs, e.g. for test status indication, definition of criteria for logical decision-making, RF power shutdown, flexible test sequence control in pulsed measurements, synchronization of external devices, and for timing control during test sequences in production.

Second internal LO source

The second internal LO source allows two ports to receive signals at different frequencies. This means that two frequencies can be measured simultaneously, e.g. the RF and the IF signal of a mixer, making the measurement twice as fast and reducing trace noise.

Four internal pulse generators and four internal pulse modulators

Four pulse generators and modulators make it possible to generate pulsed two-tone signals and bidirectional pulsed signals, e.g. for intermodulation measurements on T/R modules.

Configuration for pulsed signal measurements

The R&S®ZNA contains four internal pulse generators, which are enabled with any of the following options: R&S®ZNAxx-B4n (internal pulse modulator for port n) and R&S®ZNA-B91 (trigger board). This means that e.g. the trigger board alone enables use of the internal pulse generators to control external pulse modulators (e.g. to generate pulses with a duration of < 100 ns). Point-in-pulse measurements are delivered by the base unit; pulse profile measurements are added with the R&S®ZNA-K7 option.



The R&S®ZNA comes with an extensive range of hardware options, allowing customized configuration for the intended use.

Hardware options

Hardware options in detail		
Description	Applications and benefits	Hardware option
Direct source and receiver access ¹⁾ <ul style="list-style-type: none"> With start frequency down to 100 kHz Supports reversed coupler configuration 	<ul style="list-style-type: none"> Facilitates external test setups for power measurements across a wide frequency range Reversed coupler configuration increases dynamic range and reduces system noise figure 	R&S®ZNAxx-B16 ²⁾
R&S®ZNA four-port model with up to four internal sources	<ul style="list-style-type: none"> Short measurement times Flexible-to-configure, compact test setups, e.g. for DUTs with two converter stages 	R&S®ZNAxx-B3 ²⁾
Second internal LO source <ul style="list-style-type: none"> For simultaneous measurement of two different frequencies (e.g. RF and IF signal on mixers) 	<ul style="list-style-type: none"> Fast mixer and converter measurements Very low trace noise with frequency-converting measurements 	R&S®ZNA-B5
Four/eight true receivers (no multiplexing)	Reliable multichannel phase and antenna measurements	Provided as standard in base unit
Direct IF access, switchable to input or output, with 2 GHz analog IF bandwidth	Enhanced flexibility and sensitivity, e.g. when used in antenna measurement systems <ul style="list-style-type: none"> Provides direct access to up to eight phase-coherent receivers 	R&S®ZNA-B26
Four internal pulse generators and four internal pulse modulators	<ul style="list-style-type: none"> For measurements on pulsed signals and for flexible system integration 	R&S®ZNA-K7 R&S®ZNAxx-B4n ²⁾³⁾
Enhanced trigger and control functions (three additional trigger inputs, four trigger outputs, four pulse control I/O ports, ready for trigger, busy, RF interlock control) ⁴⁾	<ul style="list-style-type: none"> Universal system adaptation and easy system integration High reference frequency for low phase noise 	R&S®ZNA-B91
Source step attenuators, 0 dB to 70 dB in 10 dB steps	Generation of low-power stimulus signals down to -110 dBm	R&S®ZNAxx-B2n ²⁾³⁾
Receiver step attenuators, 0 dB to 35 dB in 5 dB steps	Compression-free measurements with input power up to destruction limit of +27 dBm	R&S®ZNAxx-B3n ²⁾³⁾

¹⁾ Between 100 kHz and 10 MHz, the internal coupler can only be used to a limited extent. Here, external directional components and recalibration are required.

²⁾ xx designates the R&S®ZNA model (R&S®ZNA26/R&S®ZNA43).

³⁾ n designates the port number (1/2/3/4).

⁴⁾ 1 GHz reference frequency input provided as standard.

Hardware options – principle of operation

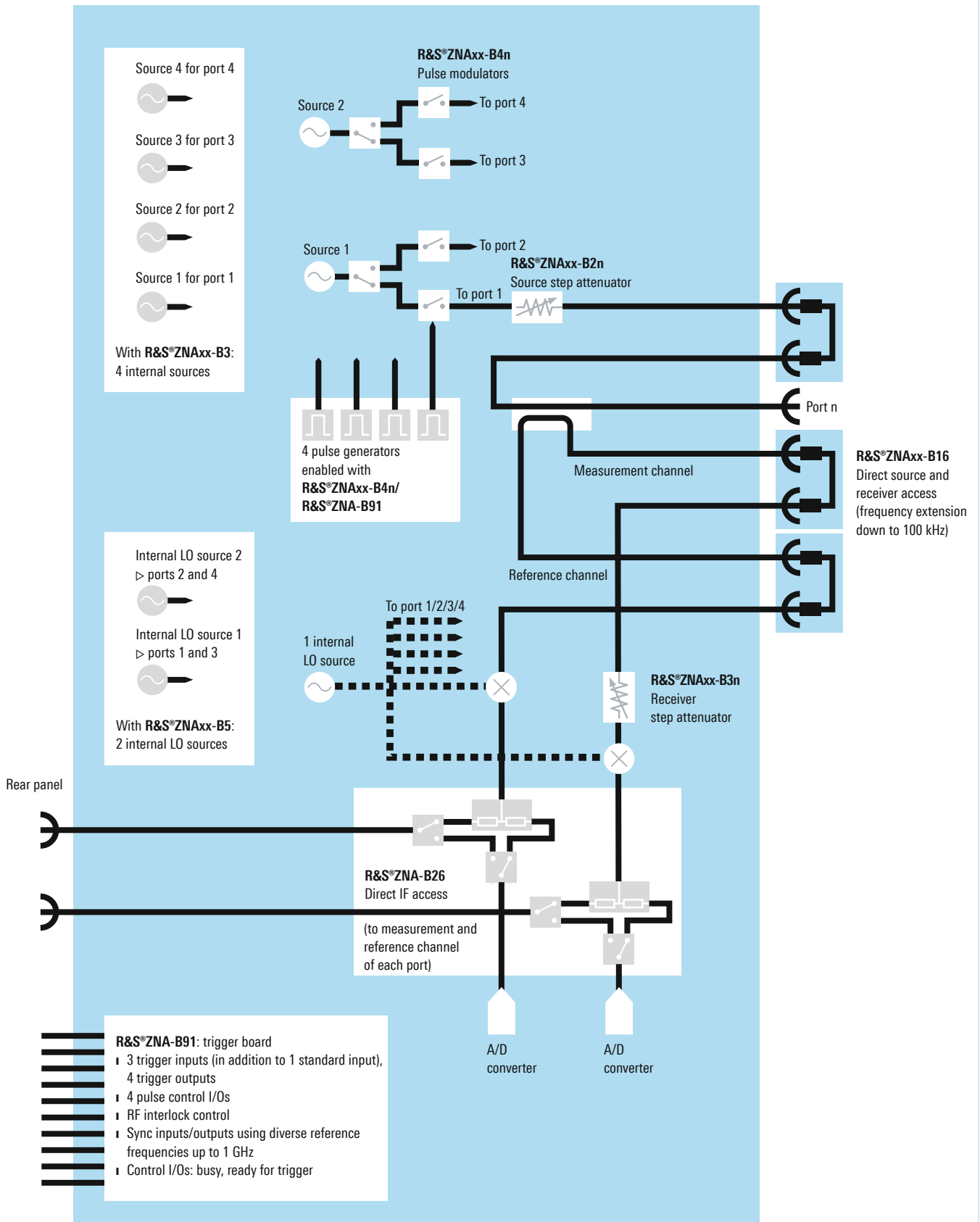

xx designates the R&S ZNA model (R&S ZNA26/R&S ZNA43).
 n designates the port number (1/2/3/4).

Unprecedented RF quality

Wide dynamic and power sweep range

The very high dynamic range of the R&S®ZNA allows the characterization of high-rejection filters. With high output powers and a wide power sweep range, the instrument can analyze the large- and small-signal behavior of amplifiers in a single sweep:

- Dynamic range: 145 dB (typ.)¹⁾, > 129 dB (specified, without options)
- Max. attainable dynamic range: 170 dB (typ.)²⁾
- Electronically controlled power sweep range up to 100 dB (typ.), interruption-free up to 40 dB (typ.)

High stability for reliable results

The R&S®ZNA test set and receivers feature excellent temperature and long-term stability. The instrument's magnitude and phase drift are very low, with values of < 0.01 dB/K and < 0.1°/K (typ.). A calibrated R&S®ZNA delivers precise measurements over several days without recalibration:

- Trace noise of 0.001 dB (RMS)
- Temperature stability of 0.01 dB/K and 0.1°/K
- Reliable measurement of high power levels thanks to 0.1 dB receiver compression for 15 dBm power level at test port
- High dynamic range of sources due to source step attenuators up to 70 dB and electronic power sweep range up to 100 dB

¹⁾ With R&S®ZNAxx-B3n option.

²⁾ Requires: maximum output power, R&S®ZNAxx-B16 option, R&S®ZNAxx-B3n option, reversed coupler configuration at receive port, and 1 Hz IF bandwidth.

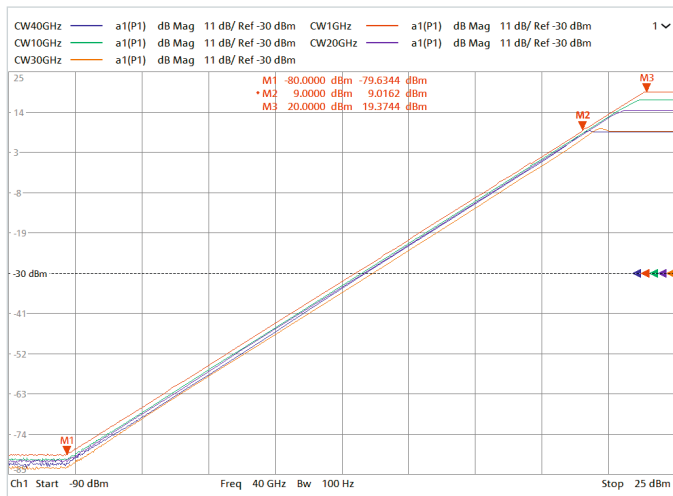

Maximum power sweep range of up to 100 dB

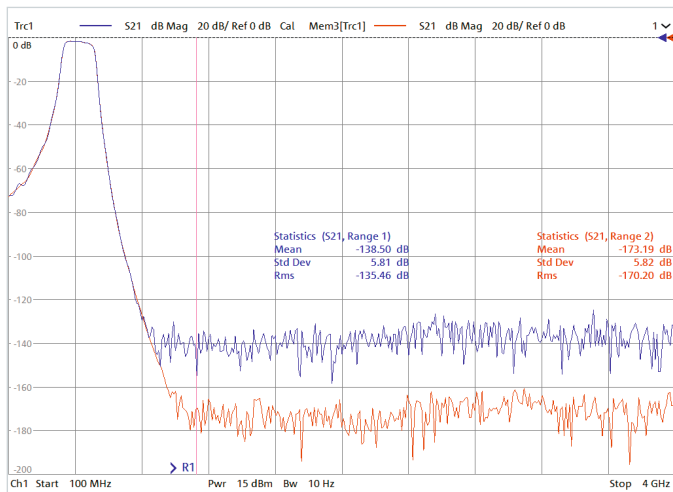

Dynamic range:

- At maximum specified output power, without options (blue trace: at 10 Hz IF bandwidth)
- At maximum specified output power and with receiver step attenuator set to 0 dB (red trace: at 1 Hz IF bandwidth)

The right calibration for every test scenario

The R&S®ZNA offers classic through, open, short, match (TOSM) calibration, which provides a maximum of precision for S-parameter measurements especially in coaxial test environments. The R&S®ZNA also supports calibration methods for DUTs in other, specific test environments, e.g. in test fixtures or on wafers, and for DUTs equipped with different types of connectors at the input and output.

Full calibration with only three standards – faster, simpler, more precise

- Through, reflect, line/line, reflect, line (TRL/LRL) for on-wafer applications, waveguides and coaxial DUTs
- Through, reflect, match (TRM) for applications in test fixtures and on wafers
- Through, short, match (TSM) and through, open, match (TOM) as alternatives to TOSM, for reduced calibration effort

Calibration for DUTs using a mix of connectors

The classic TOSM method does not provide direct calibration of test setups for DUTs equipped with different types of connectors at the input and output. The R&S®ZNA offers two alternatives to provide this type of calibration.

UOSM calibration

Unknown through, open, short, match (UOSM) calibration is the smartest way to overcome the above problem. It involves about the same effort as TOSM calibration. A through connection with unknown parameters is required, i.e. a reciprocal (but otherwise more or less arbitrary) two-port, e.g. a simple and cost-effective adapter.

Adapter removal method

As an alternative, the R&S®ZNA offers classic adapter removal calibration. This method is very robust, but requires considerably more calibration steps.

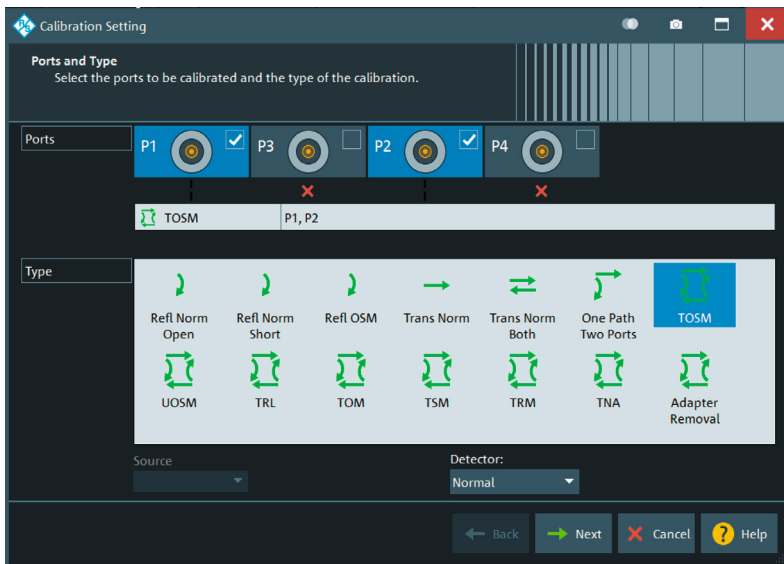

Selection of calibration methods on the R&S®ZNA

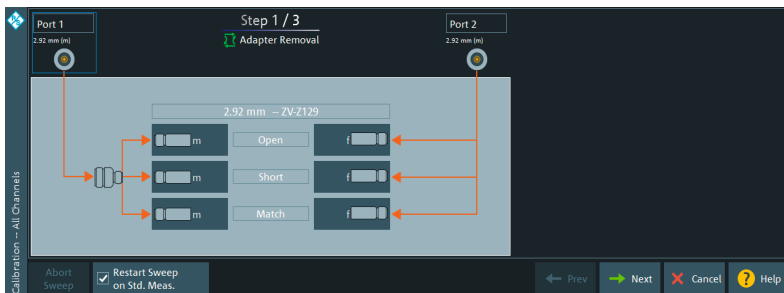

Straightforward dialogs guide the user step by step through the adapter removal calibration process for calibrating a DUT with a mix of connectors at the input and output.

Fast embedding/deembedding for impedance matching using virtual networks

Coaxial and balanced components, such as surface acoustic wave (SAW) filters used in mobile phone frontends, are specified together with the networks that match them to the impedance of the surrounding circuit. The R&S®ZNA can embed the DUT into virtual matching networks to provide realistic conditions by simulating the DUT installed in its operational environment. The R&S®ZNA offers a choice of predefined matching network topologies. If values of the individual network elements are edited, the R&S®ZNA immediately recalculates the network and embeds the DUT in the new network in real time. In addition to predefined topologies, .s2p, .s4p, .s6p and .s8p files can be read into the R&S®ZNA and used for embedding/deembedding.

Power calibration of sources and receivers

To characterize active DUTs and modules such as mixers and amplifiers, it is necessary to calibrate the source output power and the receivers in the network analyzer to deliver maximum power measurement accuracy. The parameters for power calibration can be independently configured on the R&S®ZNA, allowing optimal results to be achieved even for challenging scenarios.

Digital automatic level control (ALC)

The configurable digital ALC¹⁾ sets the source power precisely to the target value, using a reference signal that can be derived from any point in the test setup. Power fluctuations, e.g. due to drift effects, are eliminated. This provides stable, reproducible power conditions over long test cycles.

Calibration equipment

The R&S®ZV-Z1xx economy calibration kits provide robust operation up to 40 GHz. The R&S®ZV-Z2xx/R&S®ZN-Z2xx high-end calibration kits are available for more sophisticated requirements, offering calibration standards from type N through 1.0 mm (110 GHz). These kits achieve very high calibration accuracy thanks to precision manufacturing combined with S-parameter based characterization of the individual calibration standards.

Automatic calibration units

Automatic calibration units up to 67 GHz with two or four ports greatly simplify calibration, while reducing operator errors and improving calibration repeatability.

¹⁾ Feature will be available after launch.

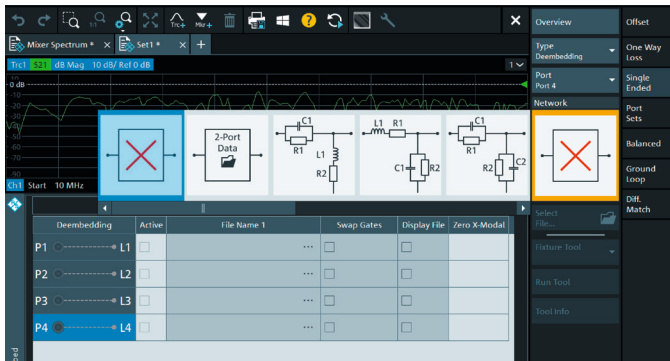

The R&S®ZNA comes with a choice of predefined matching networks whose values can be edited. If values are changed, the R&S®ZNA will immediately recalculate the network and embed the DUT in the new network in real time.

Digital automatic level control (ALC)¹⁾

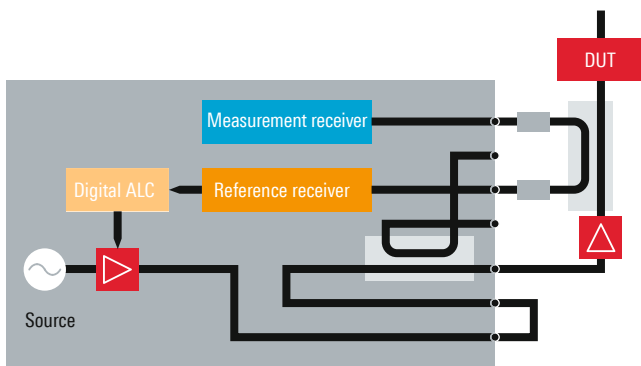

ALC operation: In the case of a high-power setup with an external preamplifier and a directional coupler, the source power is controlled to match the preamplifier output power. Drift effects can be compensated in this way, making the output power very precise and stable.

¹⁾ Feature will be available after launch.

R&S®ZN-Z32/-Z33 inline calibration units

The R&S®ZN-Z3x inline calibration units provide automatic system error correction for Rohde & Schwarz network analyzers. Unlike conventional calibration solutions, R&S®ZN-Z3x inline calibration units can remain permanently connected to the test cables. Users can recalibrate the test setup at any time by pressing a single button in the control software. There is no more time wasted with connecting and disconnecting the calibration units. The units are controlled via the CAN bus, using the R&S®ZN-Z30 inline calibration unit controller, which is in turn controlled via LAN from the vector network analyzer or a PC. Inline calibration units are the only solution for test setups where users cannot access the reference plane (calibration plane). They deliver precise and dependable measurements, e.g. for tests on satellite components in thermal vacuum chambers (TVAC).



R&S®ZN-Z33 inline calibration unit



R&S®ZV-Z1xx
economy calibration kit



R&S®ZV-Z210 and R&S®ZV-WR10
high-end calibration kits



R&S®ZV-Z2xx and R&S®ZN-Z2xx
high-end calibration kits



R&S®ZN-Z52
automatic calibration unit

Results in a minimum of time

Besides very short measurement times, the R&S®ZNA offers other features that significantly speed up data acquisition. The analyzer's high dynamic range of > 129 dB (specified) provides a large signal-to-noise ratio to deliver accurate measurements, even with high IF bandwidths, along with short measurement times. During mixer measurements, RF and IF signals can be measured simultaneously, using the second internal LO source. Compared with other instrument concepts, this yields measurement speed as high as that required for non-frequency-converting S-parameter measurements. The R&S®ZNA can pick up measurement data on all of its ports simultaneously, allowing e.g. a pair of two-port DUTs to be tested in parallel, thereby doubling the throughput.

R&S®ZN-Z33 TVAC system (with R&S®ZN-Z3ASW application software installed on PC or VNA)

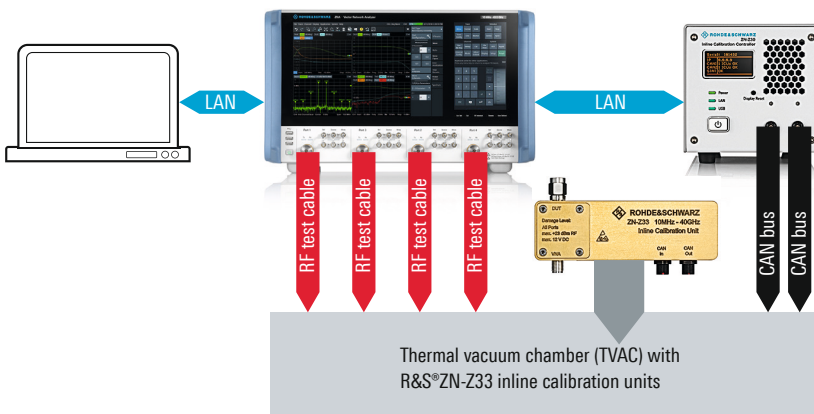

When tests are performed in thermal vacuum chambers (TVAC), the original calibration becomes invalid due to thermal drift effects in the components of the test setup. The R&S®ZN-Z33 inline calibration units remain permanently connected to the test cables, so users can recalibrate the test setup following any change in ambient temperature. Thermal characterization of the calibration units at the factory ensures precise, dependable results over a wide temperature range from -30°C to $+80^{\circ}\text{C}$.

Applications

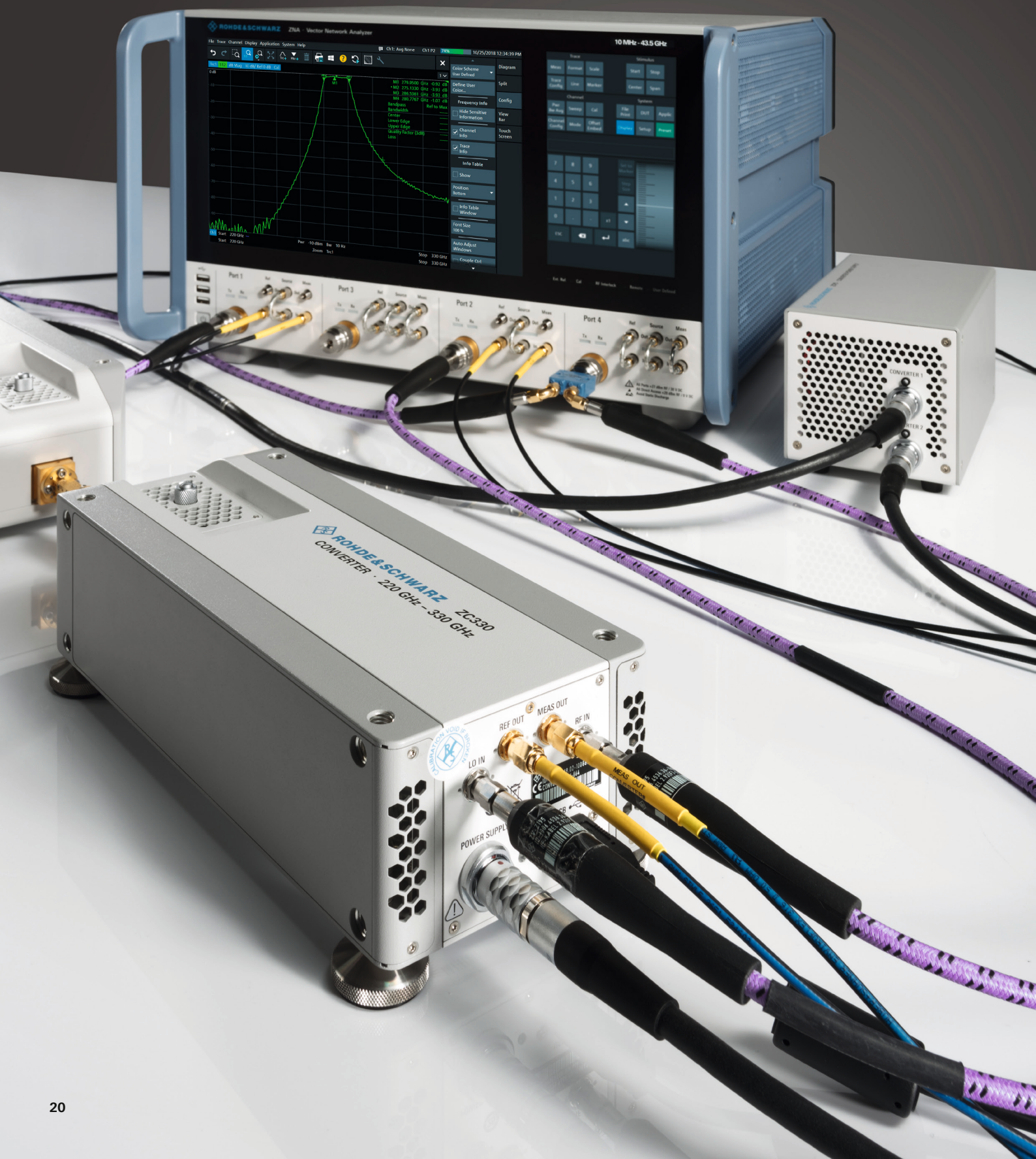

Compression point measurements

Determining the compression point is essential whenever characterizing active components. With the R&S®ZNA, compression point measurements can be flexibly combined with S-parameter measurements.

Forward and reverse power sweeps

In the case of DUTs with a high output power, e.g. on traveling wave tube (TWT) amplifiers, hysteresis effects often occur that affect determination of the compression point. To mitigate these effects, the R&S®ZNA makes it possible to determine the compression point by performing ascending and descending power sweeps.

High power measurement accuracy due to vector error correction

Instead of conventional, purely scalar error correction, compression point analysis on the R&S®ZNA relies exclusively on vector error corrected power measurements. This delivers precise results even with poorly matched DUTs.

High measurement speed for frequency-converting DUTs

Using the second LO when measuring frequency-converting DUTs doubles the measurement speed at the same IF bandwidth without increasing trace noise. Measurement time is cut in half without any compromise in accuracy.

DUT-centric measurement configuration

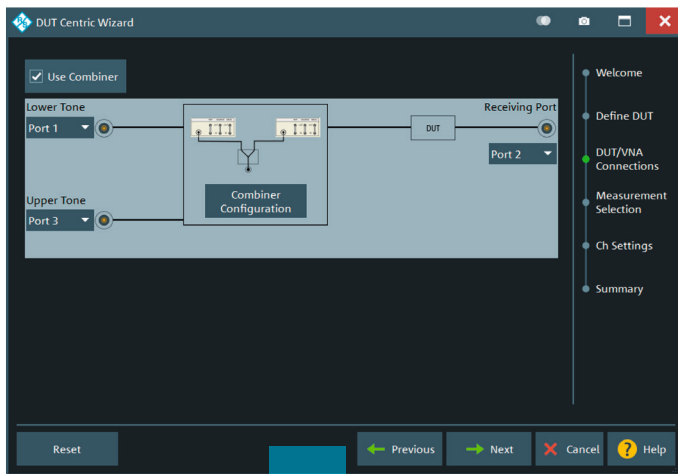

This example shows the configuration of an amplifier measurement using the DUT-centric approach.

The user first selects the type of DUT (e.g. mixer or amplifier) and then, in a step-by-step process, defines the test setup, DUT connections and measurement parameters. The desired configuration is generated very quickly while all the necessary parameters are taken into account. Measurements on the same DUT and measurements of similar type can be immediately reproduced based on a user-created DUT library.

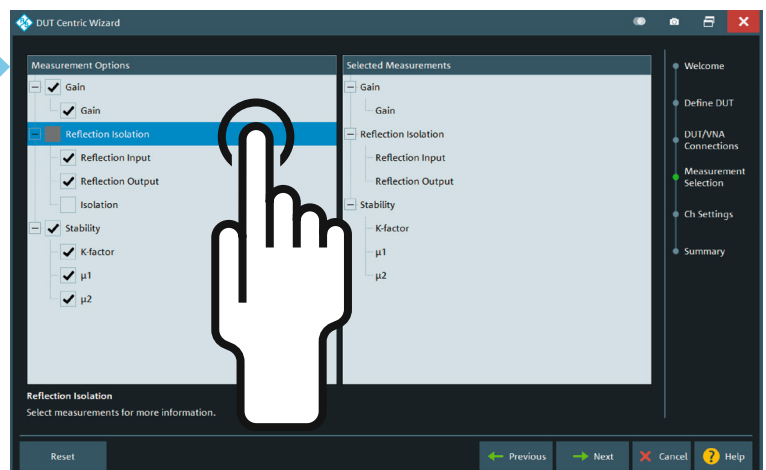

Intermodulation measurements on amplifiers and mixers

The R&S®ZNA makes it possible to determine the intermodulation characteristics of amplifiers and mixers fast and with high accuracy. It provides the following three types of intermodulation measurements:

- Frequency sweep with fixed carrier spacing
- Frequency sweep with variable carrier spacing
- Level sweep with fixed carrier spacing

Wide dynamic range and digital ALC¹⁾ for challenging intermodulation measurements

The R&S®ZNA offers major benefits especially when measuring amplifiers with very small intermodulation products. Its wide dynamic range and the excellent power handling capacity of its receivers make it possible to measure low intermodulation distortion within seconds instead of minutes.

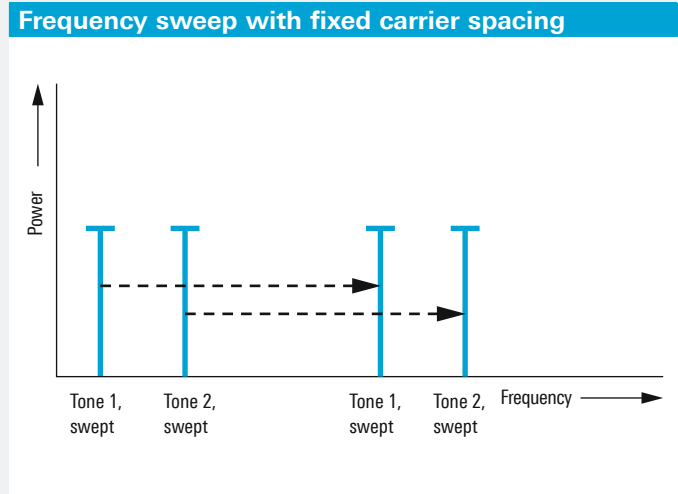

When measuring intermodulation, precise control of the powers applied to the DUT inputs is vital. Here, the R&S®ZNA makes no compromises. Automatic level control (ALC) combined with system error correction ensures a precise amplitude for the individual carriers over the entire frequency range, regardless of the DUT's input reflection coefficient.

¹⁾ Feature will be available after launch.

Comprehensive amplifier characterization, including intermodulation products, IP versus frequency, spectral measurements, and other quantities

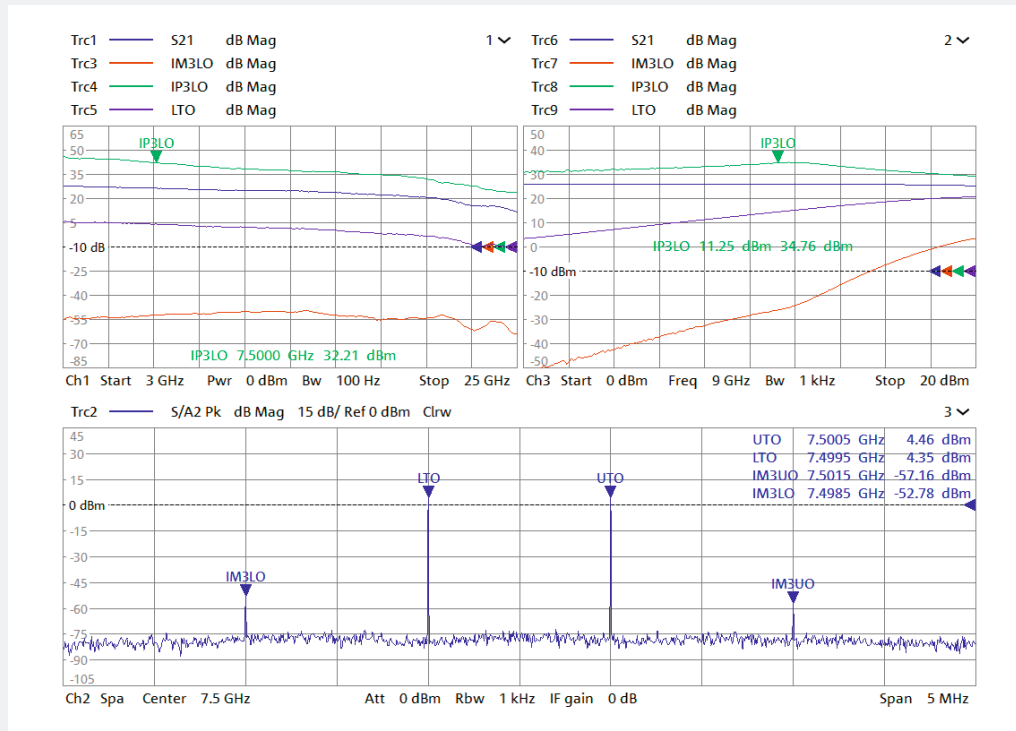

Frequency sweep with variable carrier spacing

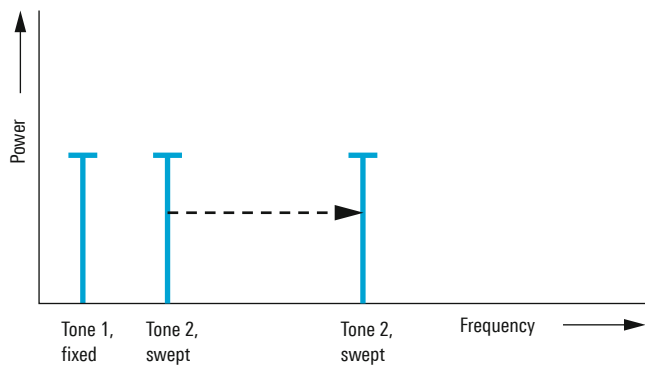

Level sweep with fixed carrier spacing

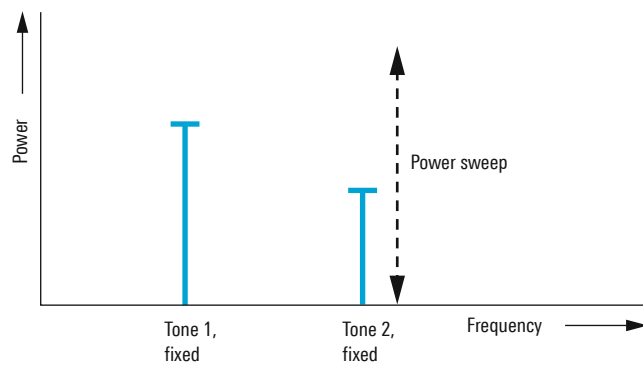

High output power and flexibility

Featuring four independent sources, the R&S®ZNA can even perform intermodulation measurements on mixers without requiring an external generator. The analyzer delivers high output powers of up to +20 dBm per test port. If this is not sufficient, the R&S®ZNA can flexibly loop external amplifiers into the signal path and precisely control them via ALC.

DUT-centric approach simplifies configuration of intermodulation measurements

The DUT-centric approach of the R&S®ZNA supports intuitive navigation during intermodulation measurements. To configure a measurement, the user first selects the type of DUT and is then guided through a dialog to define the test setup, the DUT connections, the measurement quantity or type, e.g. IM_x (x = 3, 5, 7, ...) versus frequency, the power at the DUT input and output, or a spectrum measurement. In the case of manual four-port calibration, for example, the DUT-centric approach reduces the number of required steps (i.e. connection of calibration standards and power sensor) from 26 to 16.

Power calibration GUI for an amplifier intermodulation measurement

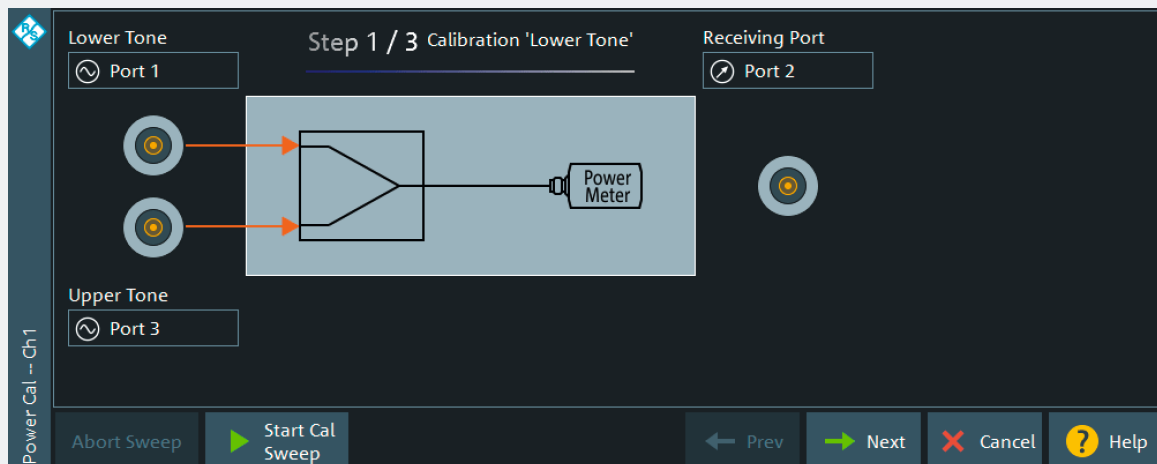

Pulsed measurements – fast and simple

The R&S®ZNA offers pulse modulators, pulse generators and synchronization I/Os for analyzing active components under pulsed conditions. Typical DUTs include components and complete T/R modules for radar applications. S-parameters, input and output powers and intermodulation products can be measured without any external components to generate RF pulses and synchronize test sequences.

Internal pulse modulators and pulse generators

The R&S®ZNA can be equipped with one pulse modulator (R&S®ZNAxx-B4n) per port. The pulse modulators can be controlled via external pulse sources or via the four internal pulse generators. The internal pulse generators can also be used to control external pulse modulators via the trigger board outputs. This allows special modulators for very short pulses to be integrated, for example.

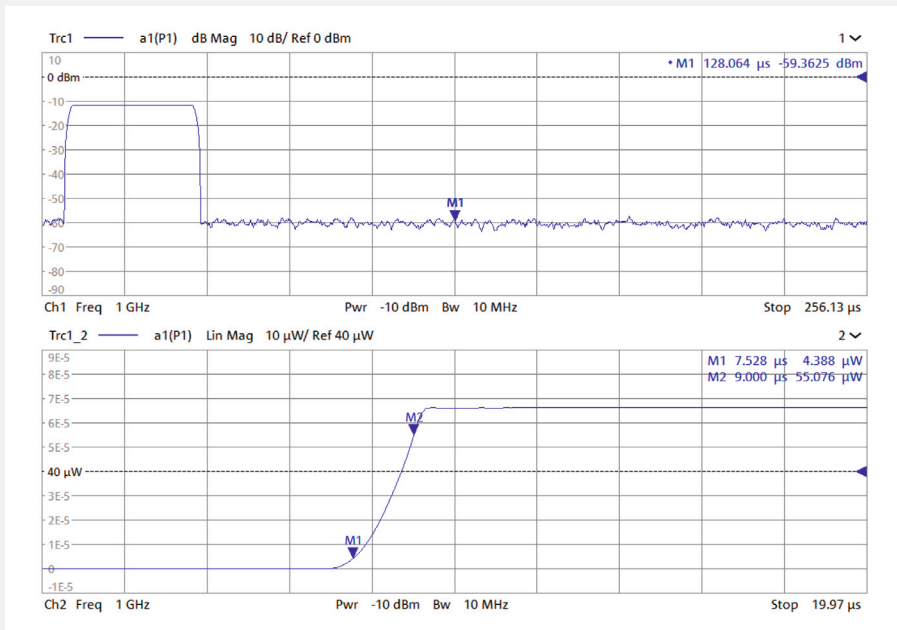

Pulse profile measurements (R&S®ZNA-K7 option)

Pulsed measurements		
Hardware	Functions	Options
	<ul style="list-style-type: none"> Four internal pulse generators with 4 ns time resolution and 100 ns minimum pulse width One pulse modulator per port with 100 ns minimum pulse width Four trigger inputs Four trigger outputs 	Available with one of the following options: R&S®ZNA-B91 or R&S®ZNAxx-B4n
Pulse profile measurements	<ul style="list-style-type: none"> Up to 30 MHz IF bandwidth 8 ns time resolution 32 ns minimum pulse width 	R&S®ZNA-K7
Point-in-pulse measurements	32 ns minimum pulse width (30 MHz IF bandwidth)	R&S®ZNA-K7 or R&S®ZNA-K17

Thanks to the test set architecture, once system error calibration has been performed, it remains valid for all types of pulsed measurements – versus frequency, level and time – even if the pulse duty cycle is changed.

Measurements versus frequency and power

The R&S®ZNA supports the common measurement techniques for pulsed applications such as point-in-pulse and pulse profile measurements.

For average pulse measurements, which rely on narrow IF bandwidths, the R&S®ZNA offers highly selective IF digital filters for the carrier signal.

Point-in-pulse measurements

Short measurement times of 32 ns are achieved for point-in-pulse measurements with IF bandwidths ranging up to 30 MHz. In addition to S-parameters, the absolute peak power can be determined in amplitude and intermodulation measurements. Flexible trigger functions support complex pulsed measurement scenarios and facilitate synchronization of measurements.

Pulse profile analysis versus time with 8 ns resolution

Equipped with the R&S®ZNA-K7 option, the R&S®ZNA supports pulse profile measurements with a time resolution of 8 ns. This technique is suitable for periodic, non-periodic and one-shot pulse scenarios.

Pulse Modulation

Coupled Settings Fixed Duty Cycle

Pulse Modulator Settings

Source	Active	Pulse Delay	Pulse Width
1	<input checked="" type="checkbox"/>	0 s	1 µs
2	<input checked="" type="checkbox"/>	0 s	2 µs
3	<input type="checkbox"/>	0 s	1 µs
4	<input type="checkbox"/>	0 s	1 µs

Duty Cycle: 0.1
Pulse Period: 1 ms

Trigger Out Settings (Rear Panel Connector)

Trig. Out	Enable	Pulse Delay	Pulse Width	Invert
A	<input checked="" type="checkbox"/>	200 ns	600 ns	<input type="checkbox"/>
B	<input checked="" type="checkbox"/>	200 ns	1.6 µs	<input type="checkbox"/>
C	<input type="checkbox"/>	0 s	1 µs	<input type="checkbox"/>
D	<input type="checkbox"/>	0 s	1 µs	<input type="checkbox"/>

Measurement Settings

Enable	Meas Delay	Acquis. Time	Auto	Bandwidth	Auto
<input type="checkbox"/>	0 s	72 ns	<input checked="" type="checkbox"/>	700 kHz	<input checked="" type="checkbox"/>

PuMo Connector as Output (Rear Panel)

PuMo Out	Enable	Invert
1	<input type="checkbox"/>	<input type="checkbox"/>
2	<input type="checkbox"/>	<input type="checkbox"/>
3	<input type="checkbox"/>	<input type="checkbox"/>
4	<input type="checkbox"/>	<input type="checkbox"/>

Internal Pulse Control
 Internal Pulse Control
 External Pulse Control

Waveform Graph: Shows PM 1, PM 2, PM 3, PM 4, Trig A, Trig B, Trig C, Trig D, and MEAS over a 2 µs period. PM 1 and PM 2 are long pulses. Trig A, B, C, D are shorter pulses. MEAS is a single point at the end of the 2 µs period.

OK Cancel Help

Configuration of parameters for pulsed signal measurements

Mixer measurements easier than ever

Fast setup and short measurement times with four internal sources and two internal LOs

The R&S®ZNA four-port model comes with up to four internal sources. Swept LO measurements and intermodulation measurements versus frequency on mixers are performed up to ten times faster compared with setups that use external generators.

Conventional conversion loss measurements with a network analyzer require two measurement steps: first, the RF input power is measured and then the IF output power. With two independent LOs for the internal receivers, the R&S®ZNA can perform both measurements simultaneously, delivering measurement speed twice as fast as any other network analyzer on the market while reducing trace noise during conversion loss and group delay measurements.

High accuracy and easy configuration thanks to R&S®SMARTerCal

The R&S®ZNA determines the return loss and scalar conversion loss of mixers and converters with high precision using R&S®SMARTerCal, a special calibration technique that combines two-port calibration and power calibration. It corrects mismatch of the test ports and mixer; no attenuators are needed to improve port matching.

DUT-centric configuration of mixer measurements

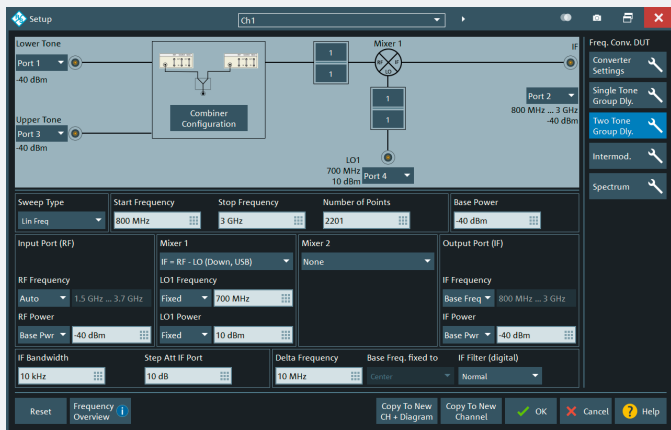

Phase measurement on a mixer



Group delay measurement on converter with two-tone signal applied to mixer

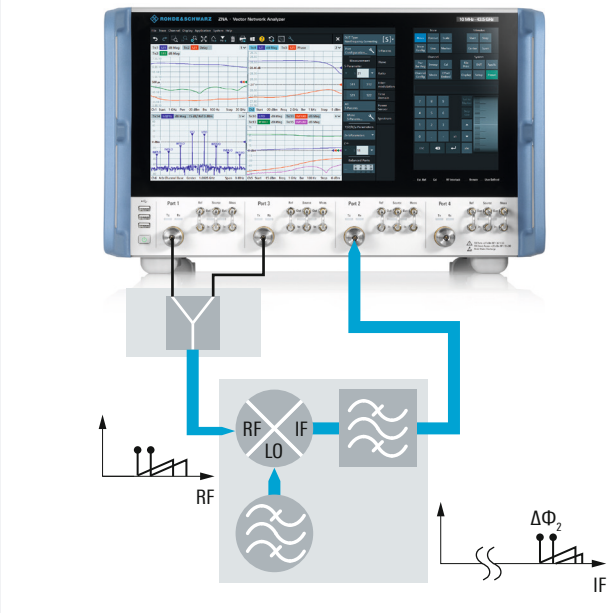

Unique approach for phase and group delay measurements on converters without LO access

The R&S®ZNA offers a special technique for measuring group delay and relative phase on frequency converters in cases where there is no access to the internal LO or the reference frequency. The analyzer uses a two-tone signal to stimulate the DUT. From the phase difference between the carriers at the input and output, the instrument calculates the group delay and the relative phase. The frequency drift and frequency modulation of the DUT's internal LO do not affect the measurement accuracy as long as the frequency deviation lies within the analyzer's IF bandwidth used for the measurement.

Relative phase measurements on frequency converters using vector error correction

Any receiving system requires a flat amplitude and phase response in order to transmit information smoothly and without disruptions. With the R&S®ZNA-K5 option, the R&S®ZNA determines the magnitude and phase for the transmission parameters of mixers and converters with LO access. This measurement uses the phase-coherent, phase-repeatable synthesizers in the R&S®ZNA in combination with a two-port UOSM calibration. The measurement itself does not require a reference mixer for frequency back-conversion. However, a calibration mixer such as the R&S®ZN-ZM292 can be used as an unknown through for calibration. The measurement is quick and easy to configure. It delivers the magnitude and phase for all four system error corrected S-parameters of a frequency converter, as well as its phase and group delay and AM/AM and AM/PM conversion.

Results of a converter measurement including return loss, conversion loss, phase and group delay

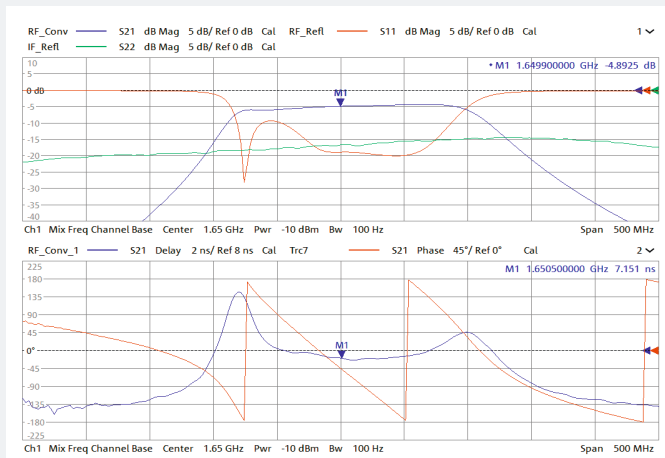

Frequency-converting measurements		
Type of measurement	Functions	Options
Scalar mixer and arbitrary frequency-converting measurements	<ul style="list-style-type: none"> ▮ Conversion loss of mixer ▮ Second source for swept LO measurements ▮ R&S®SMARTerCal for vector corrected scalar frequency-converting measurements ▮ Correction of mismatch on test ports ▮ Scalar conversion loss and return loss ▮ Isolation measurement: LO → RF and LO → IF ▮ Intermodulation products and nth-order intercept point ▮ AM/AM conversion 	R&S®ZNA-K4, R&S®ZNAxx-B3
Vector corrected converter measurements	<ul style="list-style-type: none"> ▮ Second internal LO for twice the measurement speed ▮ Two-port UOSM for vector corrected conversion loss measurements ▮ Forward and reverse conversion loss (magnitude and phase) ▮ Absolute/relative group delay ▮ AM/AM and AM/PM conversion 	R&S®ZNA-B5 R&S®ZNA-K5
Measurements on frequency converters without LO access	<ul style="list-style-type: none"> ▮ Calibration mixer ▮ Group delay and relative phase ▮ Second internal LO for twice the measurement speed and for low trace noise 	R&S®ZN-ZM292 R&S®ZNA-K9, R&S®ZNA-B5

Spectrum analysis with multichannel view

The R&S®ZNA-K1 spectrum analysis function provides a deeper insight into a DUT's behavior where S-parameter measurements versus frequency and level are not sufficient. The FFT-based spectrum analysis function can be used to measure a DUT's spurious and harmonics, providing short sweep times along with high dynamic range and fine frequency resolution. It quickly detects undesired signal components (spurious) in converters and T/R modules.

The marker-to-spectrum function directly gets to the root of problems in the event of unexpected S-parameter results, thus providing fast and extremely useful integrated diagnostics.

Multichannel view of mixer measurements with harmonic and spurious search

The spectrum analysis function is available on all ports of the R&S®ZNA. It relies on scalar system error correction, boosting accuracy and eliminating the influences of the test setup. In multichannel view, multiple results are displayed simultaneously. For example, an S-parameter measurement can be displayed along with the harmonics spectrum, or the conversion loss along with the spurious signals for a mixer.

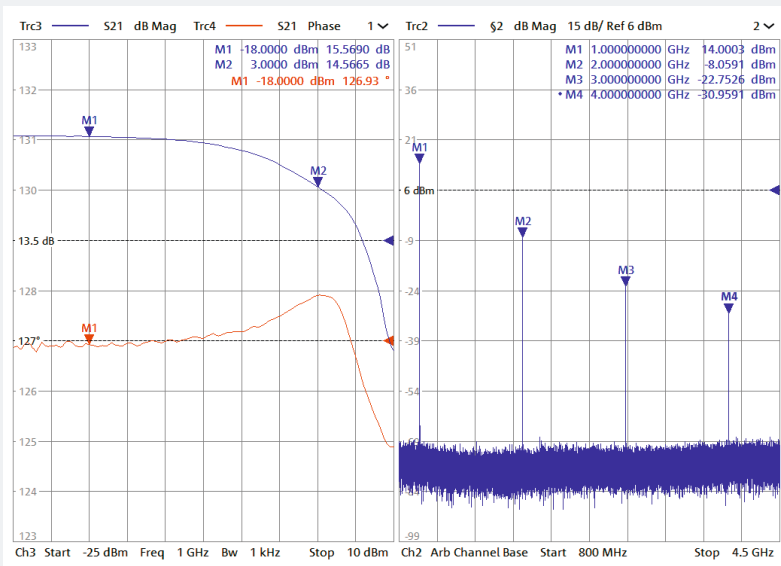

R&S®ZNA-K1 spectrum analyzer option: multichannel view of a mixer measurement with harmonic search (left) and spurious search (right)

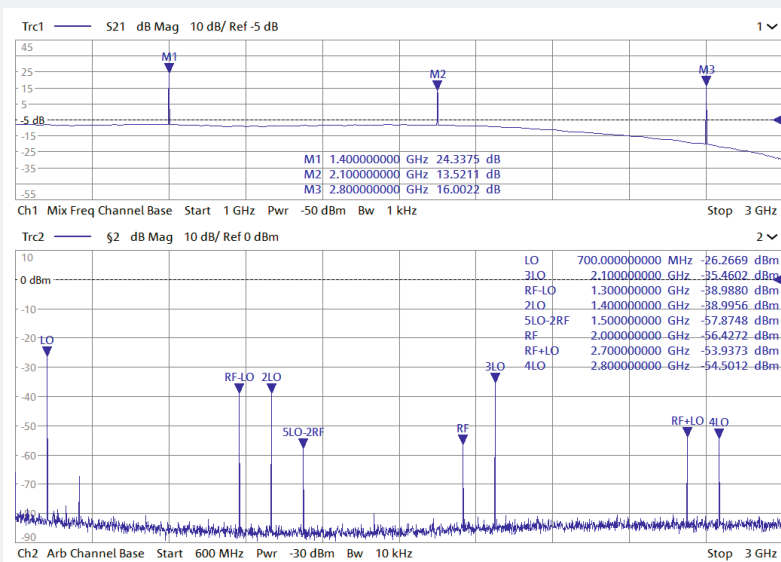

R&S®ZNA-K1 spectrum analyzer option: output spectrum of a mixer

Antenna measurements – the perfect fit

With its wide range of hardware and software functions, the R&S®ZNA can be used as the high-performing core in near-field, far-field, compact range and radar cross section (RCS) antenna test systems. Its outstanding receiver sensitivity, in combination with fast synthesizers, speeds up antenna characterization even when measuring very low signal levels. The analyzer's low trace noise, wide range of selectable IF bandwidths and various averaging functions help to find the optimum balance of short test times, high sensitivity and high accuracy.

For test systems employing external mixers, the R&S®ZNA allows flexible, independent configuration of the frequencies and powers for all sources and receivers, as well as direct IF signal path access with selectable IF frequencies.

The R&S®ZNA can provide stimulus signals from up to four sources, making it possible to measure the directional pattern of electronically controlled antenna arrays. Featuring a true parallel receiver architecture with up to eight receivers, the analyzer reliably measures the amplitude and phase of up to eight input signals. The R&S®ZNA can therefore be used as a compact multichannel receiver to design antenna arrays and subarrays for MIMO mobile communications systems, or it can be used as part of antenna test systems employing horizontally and/or vertically polarized antennas as well as reference receiving antennas.



The R&S®ZNA forms the powerful core in antenna test systems.

Benefits of the R&S®ZNA in antenna measurements	
Functions	Benefits
High receiver sensitivity and wide dynamic range	Short measurement times
Inputs for direct access to IF signal paths, selectable IF frequencies	<ul style="list-style-type: none"> ■ Use in high-frequency test systems with external mixers ■ Adaptation to optimal IF of test system
Identical RF design of all receivers	Identical characteristics of measurement and reference channels
Configuration of arbitrary frequency-converting measurements	Universal support for external mixers and millimeterwave systems
Reverse frequency sweep	<ul style="list-style-type: none"> ■ Alternating movement of positioner (CW, CCW in azimuth, plus movement in elevation) ■ Spherical near-field measurements
Extended trigger functionality	<ul style="list-style-type: none"> ■ Optimal synchronization of positioner, clock generators, etc. ■ Simple and flexible system integration
Truly parallel receiver architecture	<ul style="list-style-type: none"> ■ Measurements with up to eight receivers (no multiplexing) ■ Simultaneous measurements of multiple antenna polarizations (horizontal/vertical) and antenna arrays (MIMO)
Millimeterwave converters	Measurements in millimeterwave range

Millimeterwave measurements

Frequency extension into the terahertz range

Frequency bands in the millimeterwave and terahertz ranges are used in many applications in the mobile communications, automotive, security, semiconductor and fundamental research sectors. Automotive radar at 77 GHz/79 GHz, mobile communications in the 5G frequency bands, and radars and sensors up to and beyond 100 GHz all require the characterization of active and passive components such as filters, amplifiers, mixers and antennas.

The R&S®ZVA-Zxx and R&S®ZCxxx millimeterwave converters extend the R&S®ZNA frequency range up to 500 GHz. Many applications, in particular on-wafer component characterization and antenna measurements, call for high output powers of the frequency converters. The high operating frequencies of the components under test lead to significant losses in waveguides, probe tips and along the transmission path.

The Rohde&Schwarz frequency converters feature high output powers and excellent dynamic range. They can be used to characterize active and passive DUTs.

Special features of R&S®ZVA-Zxx and R&S®ZCxxx millimeterwave converters

- High output powers and wide dynamic range
- Easy configuration via straightforward dialog ¹⁾
- Multiport measurements with up to four converters without an external signal generator
- Variable output power (manual adjustment screw and/or control of output power by varying the input power)
- Amplifier characterization, power sweeps, compression point measurements
- Pulsed measurements
- On-wafer component characterization, integration into MPI Corporation and FormFactor (formerly Cascade Microtech) wafer prober systems
- Waveguide calibration kits (with or without sliding match) for all frequency bands of the converters
- High time and temperature stability

¹⁾ R&S®ZNA-K8 millimeterwave converter support option will be available after launch.

Two-port measurement in WM-864 band (220 GHz to 330 GHz) with an R&S®ZNA43 and two R&S®ZC330 millimeterwave converters WM-864

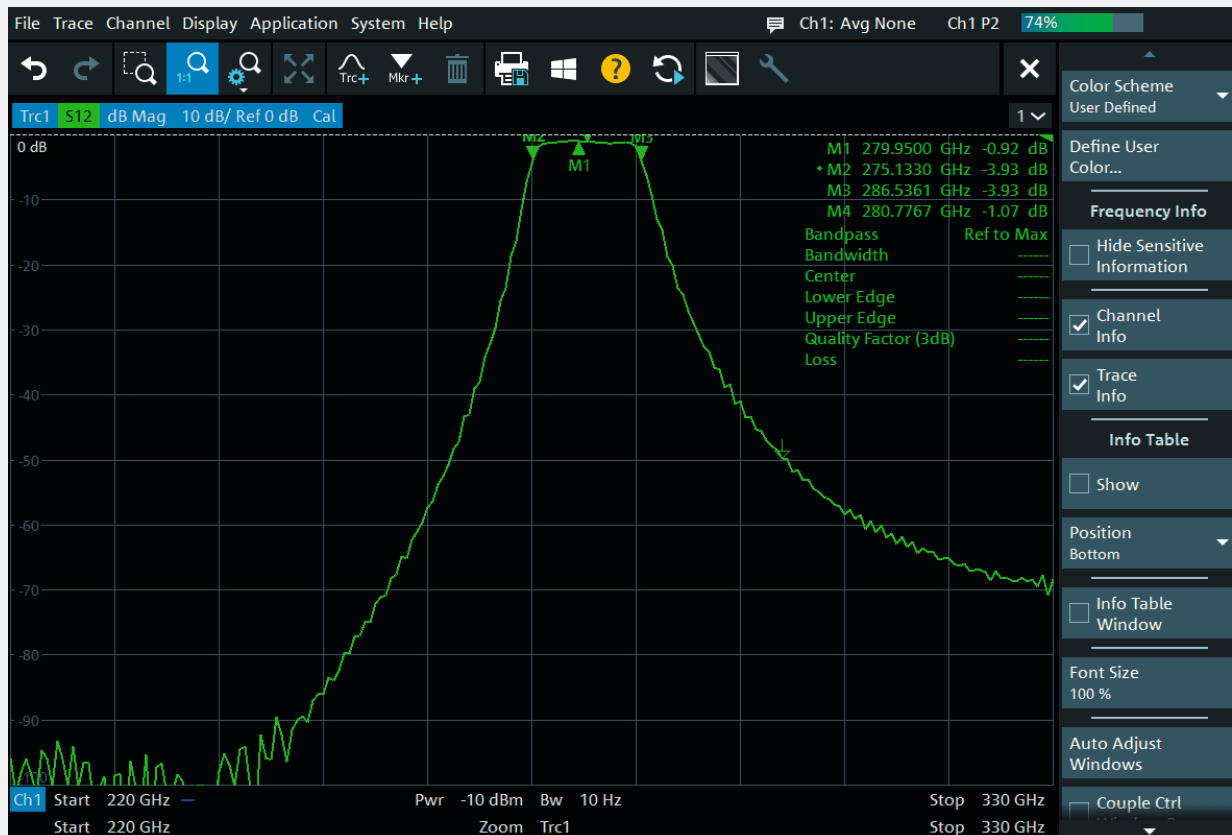



Setup for millimeterwave measurements with an R&S®ZNA43 and two R&S®ZC330 millimeterwave converters WM-864

Overview of R&S®ZCxxx millimeterwave converters

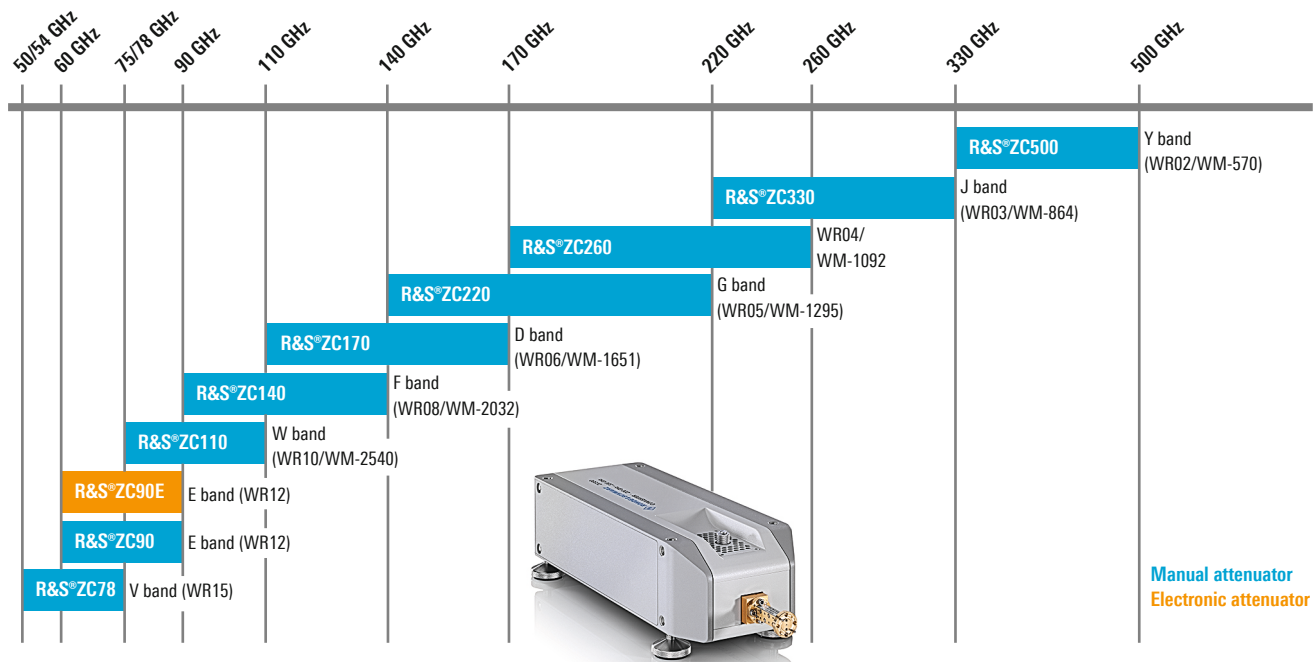

Time domain analysis and signal integrity measurements

Efficient time domain analysis with enhanced resolution

The R&S®ZNA offers powerful time domain analysis to measure components such as test fixtures, cables and connectors in the frequency and time domain. With up to 100 000 points per trace, the R&S®ZNA can easily measure even electrically long DUTs such as cables. Using the gating function, the analyzer can locate discontinuities and analyze them in detail.

A four-port R&S®ZNA can be used to determine the balanced S-parameters and other quantities such as near-end and far-end crosstalk (NEXT, FEXT) on two-wire lines and differential structures. Using prediction, the frequency range of the R&S®ZNA can be virtually extended. This yields temporal and spatial resolution substantially higher than would be expected from the DUT's and/or analyzer's frequency range.

Signal integrity at a glance with eye diagrams

Verifying the quality of a transmission path usually requires testing all of its components. The R&S®ZNA provides comprehensive analysis of cables and connectors in the time and frequency domain. The R&S®ZNA-K20 extended time domain analysis option makes it possible to compute, based on the S-parameters, the rise time, skew and eye diagrams for different bit patterns. The R&S®ZNA-K2 time domain analysis and the R&S®ZNA-K20 extended time domain analysis options are integrated into the analyzer firmware. Eye diagrams and S-parameters versus frequency and time can be analyzed and displayed simultaneously, revealing the transmission quality at a glance.

Analysis of disturbance effects and signal quality optimization

The R&S®ZNA-K20 extended time domain analysis option makes it possible to simulate the effects of unwanted disturbances such as jitter and noise on the eye diagram. The analyzer can also simulate the impact of correction algorithms, e.g. for predistortion at the transmitter end and for equalization at the receiver end. Plus, the R&S®ZNA-K20 option can be used to configure user-defined mask tests. These tests make it possible to verify compliance of the DUT's behavior with relevant standards such as USB, HDMI™ and DVI.

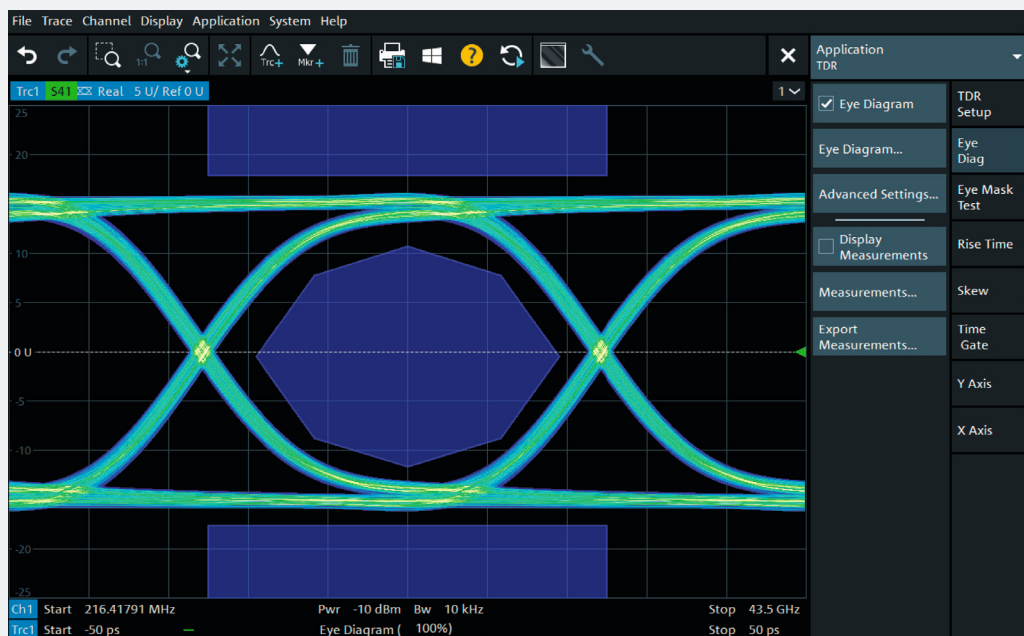

The R&S®ZNA-K20 option offers versatile signal integrity measurements, e.g. an eye diagram with a mask to verify compliance with relevant requirements. It can also be used to determine the transmission characteristics of signals with jitter or noise.

Ordering information

Designation	Type	Frequency range	Order No.
Base units			
Vector network analyzer, 2 ports, 26.5 GHz, 3.5 mm connectors	R&S®ZNA26	10 MHz to 26.5 GHz	1332.4500.22
Vector network analyzer, 4 ports, 26.5 GHz, 3.5 mm connectors	R&S®ZNA26	10 MHz to 26.5 GHz	1332.4500.24
Vector network analyzer, 2 ports, 43.5 GHz, 2.92 mm connectors	R&S®ZNA43	10 MHz to 43.5 GHz	1332.4500.42
Vector network analyzer, 2 ports, 43.5 GHz, 2.4 mm connectors	R&S®ZNA43	10 MHz to 43.5 GHz	1332.4500.43
Vector network analyzer, 4 ports, 43.5 GHz, 2.92 mm connectors	R&S®ZNA43	10 MHz to 43.5 GHz	1332.4500.44
Vector network analyzer, 4 ports, 43.5 GHz, 2.4 mm connectors	R&S®ZNA43	10 MHz to 43.5 GHz	1332.4500.45
Options			
Direct source and receiver access for R&S®ZNA26 (2 ports)	R&S®ZNA26-B16	100 kHz to 26.5 GHz	1332.4581.22
Direct source and receiver access for R&S®ZNA26 (4 ports)	R&S®ZNA26-B16	100 kHz to 26.5 GHz	1332.4581.24
Direct source and receiver access for R&S®ZNA43 (2 ports)	R&S®ZNA43-B16	100 kHz to 43.5 GHz	1332.4581.42
Direct source and receiver access for R&S®ZNA43 (4 ports)	R&S®ZNA43-B16	100 kHz to 43.5 GHz	1332.4581.44
Source step attenuator, port n, for R&S®ZNA26 ¹⁾	R&S®ZNA26-B2n	10 MHz to 26.5 GHz	1332.4630.2n
Source step attenuator, port n, for R&S®ZNA43 ¹⁾	R&S®ZNA43-B2n	10 MHz to 43.5 GHz	1332.4646.2n
Receiver step attenuator, port n, for R&S®ZNA26 ¹⁾	R&S®ZNA26-B3n	10 MHz to 26.5 GHz	1332.4700.3n
Receiver step attenuator, port n, for R&S®ZNA43 ¹⁾	R&S®ZNA43-B3n	10 MHz to 43.5 GHz	1332.4717.3n
Internal pulse modulator, port n, for R&S®ZNA26 ¹⁾	R&S®ZNA26-B4n	10 MHz to 26.5 GHz	1332.4775.4n
Internal pulse modulator, port n, for R&S®ZNA43 ¹⁾	R&S®ZNA43-B4n	10 MHz to 43.5 GHz	1332.4781.4n
3rd and 4th internal source for R&S®ZNA26 (4 ports)	R&S®ZNA26-B3	10 MHz to 26.5 GHz	1332.4523.02
3rd and 4th internal source for R&S®ZNA43 (4 ports)	R&S®ZNA43-B3	10 MHz to 43.5 GHz	1332.4617.02
Precision frequency reference (OCXO)	R&S®ZNA-B4		1332.4530.02
2nd internal LO source for R&S®ZNA (4 ports)	R&S®ZNA-B5		1332.4675.02
Direct IF access	R&S®ZNA-B26		1332.4598.02
Trigger and control I/O board	R&S®ZNA-B91		1332.4800.02
Spectrum analyzer mode	R&S®ZNA-K1		1332.5320.02
Time domain analysis (TDR)	R&S®ZNA-K2		1332.5336.02
Extended time domain analysis (including eye diagram) ²⁾	R&S®ZNA-K20		1332.4746.02
Scalar mixer and arbitrary frequency-converting measurements	R&S®ZNA-K4		1332.5342.02
Vector corrected converter measurements (without reference mixer and phase reference) ³⁾	R&S®ZNA-K5		1332.5359.02
Measurements on pulsed signals ⁴⁾	R&S®ZNA-K7		1332.5371.02
Millimeterwave converter support ⁵⁾	R&S®ZNA-K8		1332.5388.02
Group delay measurements on frequency converters without LO access ⁶⁾	R&S®ZNA-K9		1332.5394.02
Increased IF bandwidth 30 MHz	R&S®ZNA-K17		1332.5459.02
1 MHz frequency resolution	R&S®ZNA-K19		1332.5513.02
Millimeterwave converters⁷⁾			
Converter WR06 (one module)	R&S®ZVA-Z75	50 GHz to 75 GHz	1307.7400.02
Converter WR12 (one module)	R&S®ZVA-Z90	60 GHz to 90 GHz	1322.3024.02
Converter WR10 (one module)	R&S®ZVA-Z110	75 GHz to 110 GHz	1307.7000.03
Converter WR10 (one module)	R&S®ZVA-Z110E	75 GHz to 110 GHz	1307.7000.40
Converter WR03 (one module)	R&S®ZVA-Z325	220 GHz to 325 GHz	1317.0514.02
Converter WR02 (one module)	R&S®ZVA-Z500	325 GHz to 500 GHz	1317.0520.02
Converter WG 3.6 mm × 1.8 mm (one module)	R&S®ZC78	53.57 GHz to 78.33 GHz	3626.5356.02
Converter WR12 (one module)	R&S®ZC90	60 GHz to 90 GHz	1323.7600.02
Converter WR12 (one module)	R&S®ZC90E	60 GHz to 90 GHz	1323.7600.04

¹⁾ n designates the port number (1/2/3/4).

²⁾ Requires R&S®ZNA-K2.

³⁾ Requires R&S®ZNA-K4.

⁴⁾ Requires R&S®ZNA-K17.

⁵⁾ Available after launch.

⁶⁾ Requires R&S®ZNA-K4, R&S®ZNAxx-B16, and an R&S®ZNAxx-Z9 cable set for generating a two-tone signal. An R&S®ZNA (4 ports) is strongly recommended.

⁷⁾ Converters require R&S®ZNA-K8.

Designation	Type	Frequency range	Order No.
Converter WM-2540 (one module)	R&S®ZC110	75 GHz to 110 GHz	1323.7617.02
Converter WM-2032 (one module)	R&S®ZC140	90 GHz to 140 GHz	1323.7623.02
Converter WM-1651 (one module)	R&S®ZC170	110 GHz to 170 GHz	1323.7630.02
Converter WM-1295 (one module)	R&S®ZC220	140 GHz to 220 GHz	1323.7646.02
Converter WM-1092 (one module)	R&S®ZC260	170 GHz to 260 GHz	3628.5682.02
Converter WM-864 (one module)	R&S®ZC330	220 GHz to 330 GHz	1323.7669.02
Converter WM-570 (one module)	R&S®ZC500	330 GHz to 500 GHz	1323.7681.02
Calibration and verification			
Calibration kits (manual calibration)			
Calibration kit, 2.92 mm (m), 50 Ω	R&S®ZV-Z129	0 Hz to 40 GHz	1322.7471.02
Calibration kit, 2.92 mm (f), 50 Ω	R&S®ZV-Z129	0 Hz to 40 GHz	1322.7471.03
Calibration kit, 1.0 mm (f and m), 50 Ω	R&S®ZV-Z210	0 Hz to 110 GHz	5011.6588.02
Calibration kit, 3.5 mm, 50 Ω	R&S®ZV-Z235	0 Hz to 26.5 GHz	5011.6542.02
Calibration kit, 2.92 mm, 50 Ω	R&S®ZV-Z229	0 Hz to 40 GHz	5011.6559.02
Calibration kit, 2.4 mm, 50 Ω	R&S®ZV-Z224	0 Hz to 50 GHz	5011.6565.02
Calibration kit, 3.5 mm, 50 Ω	R&S®ZN-Z235	0 Hz to 26.5 GHz	1336.8500.02
Calibration kit, 2.92 mm, 50 Ω	R&S®ZN-Z229	0 Hz to 40 (43.5) GHz ⁸⁾	1336.7004.02
Waveguide calibration kits			
Waveguide calibration kit WR15 (without sliding match)	R&S®ZV-WR15	50 GHz to 75 GHz	1307.7500.30
Waveguide calibration kit WR15 (with sliding match)	R&S®ZV-WR15	50 GHz to 75 GHz	1307.7500.31
Waveguide calibration kit WR12 (without sliding match)	R&S®ZV-WR12	60 GHz to 90 GHz	1307.7700.10
Waveguide calibration kit WR12 (with sliding match)	R&S®ZV-WR12	60 GHz to 90 GHz	1307.7700.11
Waveguide calibration kit WR10 (without sliding match)	R&S®ZV-WR10	75 GHz to 110 GHz	1307.7100.10
Waveguide calibration kit WR10 (with sliding match)	R&S®ZV-WR10	75 GHz to 110 GHz	1307.7100.11
Waveguide calibration kit WR08 (without sliding match)	R&S®ZV-WR08	90 GHz to 140 GHz	1307.7900.10
Waveguide calibration kit WR08 (with sliding match)	R&S®ZV-WR08	90 GHz to 140 GHz	1307.7900.11
Waveguide calibration kit WR06 (without sliding match)	R&S®ZV-WR06	110 GHz to 170 GHz	1311.8807.10
Waveguide calibration kit WR06 (with sliding match)	R&S®ZV-WR06	110 GHz to 170 GHz	1311.8807.11
Waveguide calibration kit WR05 (without sliding match)	R&S®ZV-WR05	140 GHz to 220 GHz	1307.8106.10
Waveguide calibration kit WR05 (with sliding match)	R&S®ZV-WR05	140 GHz to 220 GHz	1307.8106.11
Waveguide calibration kit WR03 (without sliding match)	R&S®ZV-WR03	220 GHz to 325 GHz	1307.7300.30
Waveguide calibration kit WR03 (with sliding match)	R&S®ZV-WR03	220 GHz to 325 GHz	1307.7300.31
Waveguide calibration kit WR02 (without sliding match)	R&S®ZV-WR02	325 GHz to 500 GHz	1314.5550.10
Waveguide calibration kit WM-570	R&S®ZCWM-570	330 GHz to 500 GHz	1322.3099.10
Calibration units (automatic calibration)			
Inline calibration unit, one port, SMA (f)	R&S®ZN-Z32	10 MHz to 8.5 GHz	1328.7638.02
Inline calibration unit, one port, 2.92 mm (f)	R&S®ZN-Z33	10 MHz to 40 GHz	1328.7644.02
Inline calibration unit, one port, 2.92 mm (f), TVAC	R&S®ZN-Z33	10 MHz to 40 GHz	1328.7644.03
Calibration unit, 2 ports, 3.5 mm (f)	R&S®ZN-Z50	9 kHz to 26.5 GHz	1335.6904.30
Calibration unit, 4 ports, 3.5 mm (f)	R&S®ZN-Z52	100 kHz to 26.5 GHz	1335.6991.30
Calibration unit, 2 ports, 3.5 mm (f)	R&S®ZN-Z53	100 kHz to 26.5 GHz	1335.7046.32
Calibration unit, 2 ports, 2.92 mm (f)	R&S®ZN-Z54	9 kHz to 40 GHz	1335.7117.92
Calibration unit, 2 ports, 2.4 mm (f)	R&S®ZN-Z55	9 kHz to 50 GHz	1335.7181.42
Verification kits			
T-check verification device, 3.5 mm (f to m)	R&S®ZV-Z335	45 MHz to 26.5 GHz	1319.1018.02
T-check verification device, 2.92 mm (f to m)	R&S®ZV-Z329	45 MHz to 40 GHz	1319.1024.02
T-check verification device, 2.4 mm (f to m)	R&S®ZV-Z324	45 MHz to 50 GHz	1319.1030.02
Verification kit, 3.5 mm	R&S®ZV-Z435	45 MHz to 26.5 GHz	1319.1060.02
Verification kit, 2.92 mm	R&S®ZV-Z429	45 MHz to 40 GHz	1319.1076.02
Verification kit, 2.4 mm	R&S®ZV-Z424	45 MHz to 50 GHz	1319.1082.02

Designation	Type	Frequency range	Order No.
Test cables			
3.5 mm (f) to 3.5 mm (m), length: 0.6 m/1 m	R&S®ZV-Z93	0 Hz to 26.5 GHz	1301.7595.25/38
2.92 mm (f) to 2.92 mm (m), length: 0.6 m/1 m	R&S®ZV-Z95	0 Hz to 40 GHz	1301.7608.25/38
2.4 mm (f) to 2.4 mm (m), length: 0.6 m	R&S®ZV-Z97	0 Hz to 50 GHz	1301.7637.25
3.5 mm (f) to 3.5 mm (m), length: 0.6 m/0.9 m/1.5 m	R&S®ZV-Z193	0 Hz to 26.5 GHz	1306.4520.24/36/60
2.92 mm (f) to 2.92 mm (m), length: 0.6 m/0.9 m	R&S®ZV-Z195	0 Hz to 40 GHz	1306.4536.24/36
1.85 mm (f) to 1.85 mm (m), length: 0.6 m/0.9 m	R&S®ZV-Z196	0 Hz to 67 GHz	1306.4559.24/36
Hardware add-ons			
Calibration mixer, 2.92 mm (f)	R&S®ZN-ZM292	10 MHz to 40 GHz	1339.3800.02
Torque wrench for 3.5/2.92/2.4/1.85 mm connector, 8 mm width, 0.9 Nm torque	R&S®ZN-ZTW		1328.8534.35
Torque wrench for R&S®ZNA test port connector, 19 mm width, 0.9 Nm torque	R&S®ZN-ZTW		1328.8534.19
Additional removable hard disk	R&S®ZNA-B19		1332.4600.02
19" rack adapter	R&S®ZZA-KN6		1175.3056.00
Cable set for R&S®ZNA-K9 (3.5 mm for R&S®ZNA26) ⁹⁾	R&S®ZNA26-Z9		1332.4730.26
Cable set for R&S®ZNA-K9 (2.92 mm for R&S®ZNA43) ⁹⁾	R&S®ZNA43-Z9		1332.4730.43
Cable set for R&S®ZNA-K9 (2.4 mm for R&S®ZNA43) ⁹⁾	R&S®ZNA43-Z9		1332.4730.44

Warranty		
Base unit		3 years
All other items ¹⁰⁾		1 year
Options		
Extended warranty, one year	R&S®WE1	Please contact your local Rohde & Schwarz sales office.
Extended warranty, two years	R&S®WE2	
Extended warranty with calibration coverage, one year	R&S®CW1	
Extended warranty with calibration coverage, two years	R&S®CW2	
Extended warranty with accredited calibration coverage, one year	R&S®AW1	
Extended warranty with accredited calibration coverage, two years	R&S®AW2	

Your local Rohde & Schwarz expert will help you determine the optimum solution for your requirements. To find your nearest Rohde & Schwarz representative, visit www.sales.rohde-schwarz.com

⁸⁾ From 40 GHz to 43.5 GHz: Data sheet values of confidence level "measured" apply.

⁹⁾ Cable set to combine the signals from port 1 and port 3 of an R&S®ZNA (4 ports) to produce a two-tone signal. Required for intermodulation measurements and embedded LO group delay measurements with R&S®ZNA-K9 option.

¹⁰⁾ For options that are installed, the remaining base unit warranty applies if longer than 1 year. Exception: All batteries have a 1 year warranty.

Service that adds value

- | Worldwide
- | Local and personalized
- | Customized and flexible
- | Uncompromising quality
- | Long-term dependability

Rohde & Schwarz

The Rohde & Schwarz electronics group offers innovative solutions in the following business fields: test and measurement, broadcast and media, secure communications, cybersecurity, monitoring and network testing. Founded more than 80 years ago, the independent company which is headquartered in Munich, Germany, has an extensive sales and service network with locations in more than 70 countries.

www.rohde-schwarz.com

Sustainable product design

- | Environmental compatibility and eco-footprint
- | Energy efficiency and low emissions
- | Longevity and optimized total cost of ownership

Certified Quality Management

ISO 9001

Certified Environmental Management

ISO 14001

Rohde & Schwarz training

www.training.rohde-schwarz.com

Regional contact

- | Europe, Africa, Middle East | +49 89 4129 12345
customersupport@rohde-schwarz.com
- | North America | 1 888 TEST RSA (1 888 837 87 72)
customer.support@rsa.rohde-schwarz.com
- | Latin America | +1 410 910 79 88
customersupport.la@rohde-schwarz.com
- | Asia Pacific | +65 65 13 04 88
customersupport.asia@rohde-schwarz.com
- | China | +86 800 810 82 28 | +86 400 650 58 96
customersupport.china@rohde-schwarz.com

R&S® is a registered trademark of Rohde & Schwarz GmbH & Co. KG

Trade names are trademarks of the owners

PD 5215.4652.12 | Version 01.01 | January 2019 (ch)

R&S®ZNA Vector Network Analyzer

Data without tolerance limits is not binding | Subject to change

© 2018 - 2019 Rohde & Schwarz GmbH & Co. KG | 81671 Munich, Germany



5215465212