



Version

04.03

Power Reflection Meter R&S®NRT

200 kHz to 4 GHz – 0.3 mW to 2000 W

- ◆ Power measurement on transmitters, amplifiers, industrial RF and microwave generators
- ◆ Simultaneous display of power and reflection
- ◆ Measurement of average power irrespective of modulation mode
- ◆ Measurement of peak power, crest factor and average burst power
- ◆ Compatible with all main digital standards, such as GSM/EDGE, WCDMA, cdmaOne, CDMA2000®, PHS, NADC, PDC, TETRA, DECT, DAB, DVB-T
- ◆ Intelligent sensors: simply plug in and go
- ◆ IEC625 bus (IEEE 488 bus) and RS-232 interface
- ◆ Digital interface between sensor and base unit
- ◆ Direct connection of sensor to a PC

The Power Reflection Meter R&S®NRT – a concept satisfying high

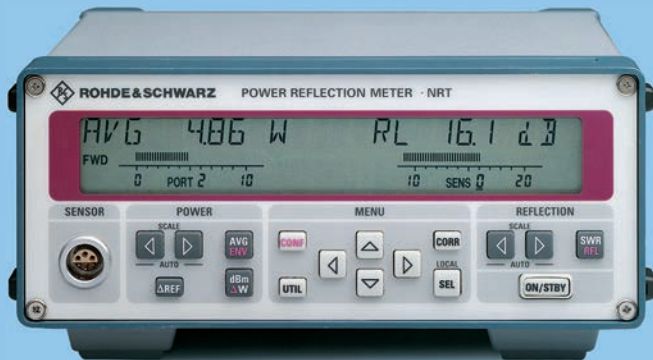

- ◆ For mobile use, service, development, production and quality management
- ◆ Up to three (four) measurement channels
- ◆ Digital sensor interface
- ◆ Sensor operation directly on PC
- ◆ Sensors of the predecessor model R&S®NAP connectible

Directional power meters are connected between source and load and measure the power flow in both directions. The power applied to the load and the reflection can thus be measured.

Compared to low-cost instruments, power meters such as the R&S®NRT provide a number of benefits: most importantly high measurement accuracy through excellent directivity and a measurement method that determines the average power like a thermal power meter. The instruments thus provide correct measurement results even in case of modulation or in the presence of several carriers. In addition, all power sensors offer low insertion loss, excellent matching and outstanding intermodulation characteristics: the signal to be measured is virtually unaffected, the sensor is fully transparent.

Directional power meters are used to measure power and reflection under operational conditions. Typical applications are in installation, maintenance and monitoring of transmitters, antennas and RF generators in industrial and medical fields.

Versatile measurement functions

The Power Reflection Meter R&S®NRT is the right choice: rugged, accurate and compact. Due to its large variety of measurement functions and high accuracy it is suitable for classic applications in mobile use as well as for use in research, development, production and quality management.

From HF through to digital radiocommunications

With the Power Sensors R&S®NRT-Z43 and R&S®NRT-Z44, the R&S®NRT is tailor-made to meet present and future requirements of radiocommunications: the wide frequency range from 200 (400) MHz to 4 GHz covers all relevant frequency bands, the measurement method is compatible with all common analog and in particular digital modulation standards: GSM/EDGE, WCDMA, cdmaOne, CDMA2000®, PHS, NADC, PDC, TETRA, DECT, DAB, DVB-T and many more. The Directional Power Sensor R&S®NRT-Z14 (25 MHz to 1 GHz) is available for the frequency bands of conventional radiocommunications. Moreover, the sensors of the predecessor R&S®NAP can be connected via the option R&S®NRT-B1.

Measurement directly on PC

While conventional power sensors can only be used in conjunction with a base unit, the R&S®NRT family is a step further ahead: the sensors are self-contained measuring instruments which are able to communicate with the base unit or with a PC via a standard serial data interface.

Apart from the possibility of operating the sensor directly at the RS-232 or PC Card interface of a PC, this concept provides a number of further benefits: practically maintenance-free base unit, high immunity to radiated interference – an important feature for measurements in the near field of antennas – and remote operation over very long distances (up to 500 m).

ghest demands

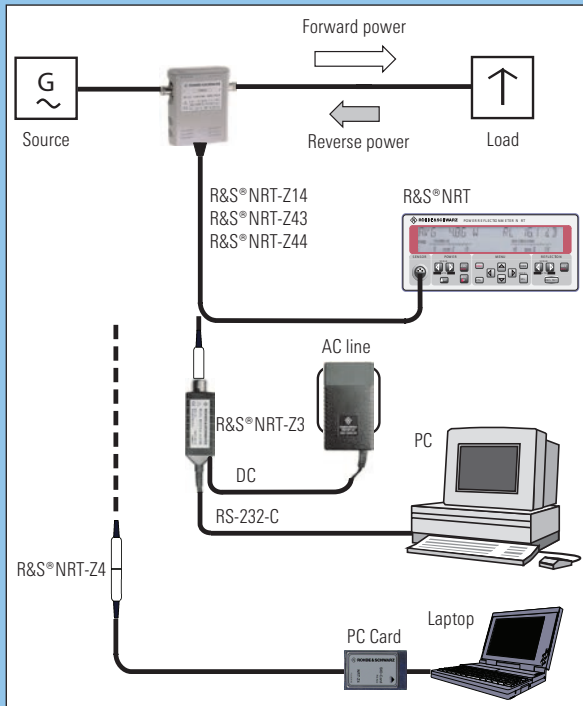

Power and reflection measurement with the R&S®NRT-Z14, R&S®NRT-Z43 and R&S®NRT-Z44: readout of results either on base unit or directly on PC

- ◆ Consideration of cable loss between sensor and load
- ◆ Acoustic SWR monitoring
- ◆ Indication of maximum and minimum values
- ◆ Quasi-analog bargraph display
- ◆ Choice between measurement at the source or at the load

Versatile through options

The R&S®NRT base unit comes with an IEC bus (IEEE 488) and RS-232 interface, both to SCPI standard. Three options allow the R&S®NRT to be adapted to different applications:

- ◆ An additional test input allows the sensors of the predecessor model R&S®NAP to be connected, thus covering the frequency range from 200 kHz with power up to 1 kW and above (R&S®NRT-B1)
- ◆ Two additional test inputs for sensors of type R&S®NRT-Z (option R&S®NRT-B2) allow monitoring of up to three test points (to be scanned by manual or remote control)
- ◆ Battery and built-in charger enable mobile use (R&S®NRT-B3)

Ease of operation

With its large display and a manageable number of clearly laid-out keys, operation of the R&S®NRT base unit is extremely easy. Switchover between the main functions is made at a keystroke. Additional settings are selected in three clearly arranged menus, each of which can be accessed at a keystroke.

A large variety of functions is available for daily routine measurements:

- ◆ Choice between average power, average burst power, peak envelope power (PEP) and peak-to-average power ratio (crest factor)
- ◆ Switchover between forward power and absorbed power

- ◆ Measurement of power differences in dB or %
- ◆ Choice between return loss, SWR, reflection coefficient and reverse-to-forward power ratio in % in reflection measurements
- ◆ Display of amplitude distribution (CCDF) for modulated signals



The battery, the R&S®NAP sensor connector and two R&S®NRT sensor connectors are accessible on the rear panel

Sensor with PC interface

Directional Power Sensors R&S®NRT-Z14/-Z43/-Z44

These power sensors can be used as self-contained measuring instruments with digital interface even without the base unit. In addition to a directional coupler and analog section, they comprise a processor kernel for control of the hardware and remote interface and for processing the measured data (temperature compensation, linearization, zeroing and frequency-response correction). This compact concept provides a wealth of measurement functions without the restrictions of conventional analog solutions.



Average power (rms value)

This measurement function returns for any type of test signal – whether modulated, unmodulated or several carriers – the average value of the power, i.e. a result as provided by a thermal power meter. It features a measurement range of 35 dB to 40 dB as well as high measurement accuracy.

Peak envelope power (PEP) and crest factor

These two parameters provide information on the peak power of a modulated envelope and thus describe the overdrive characteristics of transmitter output stages. The result of the crest factor measurement is referenced to the average power and read out in dB. The measurements are carried out with a video bandwidth adjustable in several steps

and allow determination even of short-time, high-power peaks generated, for example, by CDMA base stations.

Average burst power

This function can be used for measuring modulated and unmodulated bursts. The measurement is based on the average power and the duty cycle, which may be defined by the user or determined automatically by the power sensor.

Complementary cumulative distribution function (CCDF)

This function measures the probability of the peak envelope power exceeding a preset threshold so that the amplitude distribution of transmitted signals with non-determined envelope can be determined.

Matching

The power sensor calculates the matching of the load from the average values of forward and reverse power. This parameter can be output in all common representations – as return loss, SWR, reflection coefficient or power ratio in %. Since the reverse power measurement channel is more sensitive than the forward channel, matching measurements can already be made at very low powers.

Excellent shielding

The power sensors feature excellent shielding so that emissions from the microprocessor or from the digital data stream on the connecting cable are completely blocked out. Any radiated emissions at the RF connectors are below the limit of detection. The excellent intermodulation characteristics keep unwanted frequency components resulting from the insertion of the power sensor to a minimum. These are all good reasons to use these power sensors not only for testing but also in fixed installations.

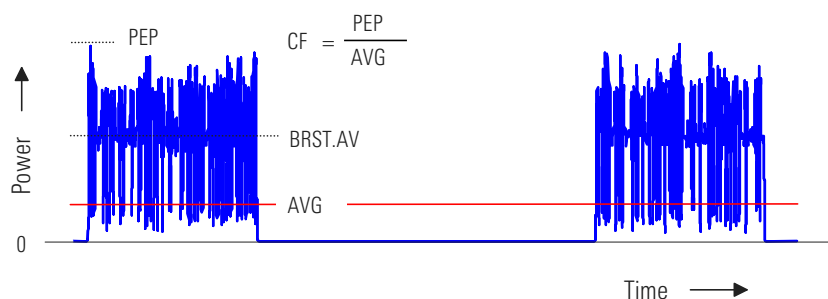

The main parameters of modulated RF shown in the example of a TDMA signal (one active timeslot) with $\pi/4$ DQPSK modulation:
average power (AVG)
peak envelope power (PEP)
crest factor (CF)
average burst power (BRST.AV)



Windows User Interface R&S® V-NRT

Direct power monitoring on PC

This is the most economical way of performing high-precision power and reflection measurements with the Power Sensors R&S®NRT-Z14, R&S®NRT-Z43 and R&S®NRT-Z44. Via the Interface Converters R&S®NRT-Z3 and R&S®NRT-Z4, they can be operated on the serial RS-232 or PC Card interface of any PC. In addition to purely remote-controlled applications, e.g. power monitoring in transmitter stations and EMC test systems, this solution is ideal where the data is to be collected by a computer. This may be in the development laboratory as well as in the maintenance of base stations, where in addition to power and reflection other parameters have to be measured and recorded. A Windows user interface (R&S®V-NRT, supplied with the sensors) is available for all these applications. This program allows setting of all the available measurement functions as well as display and storage both of individual results and of whole measurement series.

Directional Power Sensors R&S®NAP-Z

The following three power sensors of the predecessor R&S®NAP are available for performing measurements in the frequency range starting from 200 kHz or on powerful sources with a nominal power of up to 1 kW or 2 kW.

R&S®NAP-Z6/-Z7/-Z8

These sensors can be operated via the option R&S®NRT-B1 on the R&S®NRT base unit and allow average power and matching to be measured. As with the R&S®NRT sensors, directional couplers with high directivity and rectifying diodes exclusively operating in the square range allow high measurement accuracy independent of the signal waveform.

Overview of directional power sensors

Type	Frequency range	Power range
R&S®NRT-Z14	25 MHz to 1 GHz	0.006 W to 120 W (average value), 300 W (peak)
R&S®NRT-Z43	400 MHz to 4 GHz	0.0007 W to 30 W (average value), 75 W (peak)
R&S®NRT-Z44	200 MHz to 4 GHz	0.003 W to 120 W (average value), 300 W (peak)
R&S®NAP-Z6	25 MHz to 1 GHz	0.3 W to 1100 W
R&S®NAP-Z7	0.4 MHz to 80 MHz	0.05 W to 200 W
R&S®NAP-Z8	0.2 MHz to 80 MHz	0.5 W to 2000 W

High directivity means high measurement accuracy

The two main parameters for specifying the accuracy of a directional power meter are the power measurement uncertainty with matched load and the directivity. The directivity is a measure of the selectivity of the directional coupler between forward and reflected wave and influences the accuracy both of the reflection and the power measurement.

Directivity defines the absolute maximum for the measurable return loss. The return loss of a load featuring good matching can only be measured with low measurement uncertainty if the directivity is sufficiently high, as for example with the Directional Power Sensors R&S®NRT-Z and R&S®NAP-Z.

High directivity is also required for accurate power measurements on mismatched loads. The use of low-cost instruments may lead to considerable measurement uncertainty, with too high or too low values being indicated depending on the phase of the load reflection coefficient.

Versatile applications



The R&S® NRT is also ideal for mobile use, e.g. for measurements on GSM antennas

Continuous monitoring of transmitter systems

Many applications call for continuous monitoring of power and reflection, e.g. to enable fast reaction in case of any damage to the antenna. Apart from providing high accuracy, the measuring instrument must not affect SWR and attenuation in the antenna feeder nor should it generate any interfering signals. This means very good matching, low insertion loss and excellent inter-modulation characteristics: all these features are of course provided by the Directional Power Sensors R&S®NRT-Z14, R&S®NRT-Z43, and R&S®NRT-Z44 as standard. On top of this, the sum power is indicated when a multicarrier signal is applied – a feature rarely found in other directional power sensors. Since the length of the connecting cable is not critical because of digital data transfer, the Directional Power Sensors R&S®NRT-Z14, R&S®NRT-Z43 and R&S®NRT-Z44 can be fitted where they measure most accurately: at the antenna feedpoint.

Results can be evaluated and recorded either at the R&S®NRT base unit or directly at the PC. If fitted with three test inputs (option R&S®NRT-B2), the R&S®NRT allows monitoring of several antennas.

Fit for mobile use

Low weight, ease of operation, clearly arranged result display and in particular its rugged design and battery powering facility make the R&S®NRT an ideal measuring instrument for use in installation, maintenance and repair, e.g. of digital mobile radio base stations.

The optional Battery Supply R&S®NRT-B3, consisting of battery and built-in quick charger, allows eight hours of continuous operation and recharging within two hours. And if the time factor is crucial, the instrument can be made fit for twenty minutes operation by charging the battery for as little as five minutes. Should recharging of the battery not be possible at all, the battery can be replaced in next to no time. The R&S®NRT and its accessories can be accommodated in a weatherproof carrying bag.

$$CF = \frac{PEP}{AVG}$$

BRST.AV

AVG



The R&S® NRT during installation of a mobile radio base station

Power measurement with digital modulation

In contrast to many other directional power meters allowing measurement of RF and microwave signals with unmodulated envelope only, the Power Sensors R&S® NRT-Z14, R&S® NRT-Z43 and R&S® NRT-Z44 have been designed to meet also the requirements of digitally modulated signals. The foremost feature of these sensors is that they are able to correctly measure the average power (rms value) of a signal independent of its envelope, i.e. they behave like a thermal power meter. This function provides the best in accuracy and measurement range (35 dB to 40 dB).

For measurements in TDMA systems the “average burst power” function allows measurement of the transmitter power in an active timeslot. If several timeslots are active, as in the case of base stations, the average power over all timeslots can be determined with the “average power” function. Overshoots at the beginning of a timeslot or peak values caused by modulation (e.g. with $\pi/4$ DQPSK) can be measured down to a minimum duration of 200 ns (R&S® NRT-Z43/-Z44) and respectively 1.5 μ s (R&S® NRT-Z14) with the aid of the “peak envelope power” function.

For measurements on CDMA signals according to WCDMA, cdmaOne or CDMA2000® with the Directional Power Sensors R&S® NRT-Z43/-Z44, the “peak envelope power” function can also be used to advantage in addition to the “average power” function. It enables measurement of the short-time peak values that are approx. 10 dB above the average value, thus providing information on the overdrive capability of the transmitter output stage. The peak envelope power can be read out as an absolute value in W or dBm or as a relative value in dB, referenced to the average value (as crest factor).

The complementary cumulative distribution function (CCDF) is available for determining the signal amplitude distribution. This function provides information about the percentage of time during which the peak envelope power exceeds a preset threshold.

Specifications

	<i>Sensor</i>	R&S®NRT-Z14	R&S®NRT-Z43	R&S®NRT-Z44
	<i>Parameter</i>			
General data (max. power see diagram)	Power measurement range¹⁾	0.006 W to 120 W (average) 300 W (peak)	0.0007 W to 30 W (average) 75 W (peak)	0.003 W to 120 W (average) 300 W (peak)
	Frequency range	25 MHz to 1 GHz	400 MHz to 4 GHz	200 MHz to 4 GHz
	SWR (referenced to 50 Ω)	1.06 max.	1.07 max. from 0.4 GHz to 3 GHz 1.12 max. from 3 GHz to 4 GHz	1.07 max. from 0.2 GHz to 3 GHz 1.12 max. from 3 GHz to 4 GHz
	Insertion loss	0.06 dB max.	0.06 dB max. from 0.4 GHz to 1.5 GHz 0.09 dB max. from 1.5 GHz to 4 GHz	0.06 dB max. from 0.2 GHz to 1.5 GHz 0.09 dB max. from 1.5 GHz to 4 GHz
	Directivity²⁾	30 dB min.	30 dB min. from 0.4 GHz to 3 GHz 26 dB min. from 3 GHz to 4 GHz	30 dB min. from 0.2 GHz to 3 GHz 26 dB min. from 3 GHz to 4 GHz
Average power measurement^{3/4)}	Definition	mean value of carrier power, averaged over several modulation cycles (thermal equivalent, true rms value in case of voltage measurement)		
	Power measurement range⁵⁾ CF (crest factor): peak-to-average ratio	0.03 [0.006] W to 300 W: CW, FM, φM, FSK or GMSK 0.03 [0.006] W to 300 [50] W/CF ⁶⁾ : other modulation modes	0.007 [0.0007] W to 75 W: CW, FM, φM, FSK, GMSK or equivalent to 30 [3] W ⁶⁾ : (W)CDMA, DAB/DVB-T to 75 [7.5] W/CF ⁶⁾ : other modulation modes	0.03 [0.003] W to 300 W: CW, FM, φM, FSK, GMSK or equivalent to 120 [12] W ⁶⁾ : (W)CDMA, DAB/DVB-T to 300 [30] W/CF ⁶⁾ : other modulation modes
	Modulation	for all kinds of analog and digital modulation; lowest frequency component of signal envelope should exceed 7 Hz for steady indication		
	Measurement uncertainty⁷⁾ at 18 °C to 28 °C, CW signal	3.2% of rdg (0.14 dB) ⁸⁾ from 40 MHz to 1 GHz 4.0% of rdg (0.17 dB) ⁸⁾ from 25 MHz to 40 MHz plus zero offset	3.2% of rdg (0.14 dB) ⁹⁾ plus zero offset	3.2% of rdg (0.14 dB) ⁹⁾ from 0.3 GHz to 4 GHz 4.0% of rdg (0.17 dB) ⁹⁾ from 0.2 GHz to 0.3 GHz plus zero offset
	Modulated signal	same as CW signal, plus errors due to modulation		
	Zero offset	±0.004 [±0.0008] W ¹⁰⁾	±0.001 [±0.0001] W ¹⁰⁾	±0.004 [±0.0004] W ¹⁰⁾
	Typ. errors due to modulation¹¹⁾	FM, φM, FSK, GMSK: ±0% of rdg (0 dB) AM (80%): ±3% of rdg (±0.13 dB) EDGE, TETRA ¹²⁾ : ±0.5% of rdg (±0.02 dB) 2 CW carriers: ±2.0% of rdg (±0.09 dB)	FM, φM, FSK, GMSK: ±0% of rdg (0 dB) AM (80%): ±3% of rdg (±0.13 dB) cdmaOne, DAB ¹²⁾ : ±1% of rdg (±0.04 dB) CDMA2000 [®] (3X) ¹³⁾ : ±2% of rdg (±0.09 dB) EDGE ¹²⁾ : ±0.5% of rdg (±0.02 dB) WCDMA ¹⁴⁾ : ±2% of rdg (±0.09 dB) DVB-T ¹²⁾ : ±2% of rdg (±0.09 dB) π/4 DQPSK: ±2% of rdg (±0.09 dB) 2 CW carriers: ±2% of rdg (±0.09 dB)	
	Temperature coefficient¹⁵⁾	0.25%/K (0.011 dB/K): 40 MHz to 1 GHz 0.40%/K (0.017 dB/K): 25 MHz to 40 MHz	0.25%/K (0.011 dB/K): 0.4 GHz to 4 GHz	0.25%/K (0.011 dB/K): 0.3 GHz to 4 GHz 0.40%/K (0.017 dB/K): 0.2 GHz to 0.3 GHz
Measurement time/ averaging factor¹⁶⁾ Values in () for high resolution setting	1.40 (4.9) s / 32 (128) 0 W to 0.2 W 0.37 (1.4) s / 4 (32) 0.2 W to 2 W 0.26 (0.4) s / 1 (4) 2 W to 300 W	1.4 (4.9) s / 32 (128) 0 W to 0.05 W 0.37 (1.4) s / 4 (32) 0.05 W to 0.5 W 0.26 (0.4) s / 1 (4) 0.5 W to 75 W	1.4 (4.9) s / 32 (128) 0 W to 0.2 W 0.37 (1.4) s / 4 (32) 0.2 W to 2 W 0.26 (0.4) s / 1 (4) 2 W to 300 W	
Average burst power measurement^{3/4)} Video bandwidth settings in ⇄	Definition	average power value of periodic RF bursts based on the measurement of the average power under consideration of burst width t and repetition rate 1/T: average burst power = average power × T/t t and T can be predefined (calculate mode) or measured (measure mode)		
	Power measurement range			
	Calculate mode ⁵⁾	0.03 [0.006] W × (T/t) up to specified upper limit of average power measurement	0.007 [0.0007] W × (T/t) up to specified upper limit of average power measurement	0.03 [0.003] W × (T/t) up to specified upper limit of average power measurement
Measure mode (only with forward direction 1 → 2)	same als calculate mode, but at least 2 (4) W values in () for "FULL" video bandwidth setting	same als calculate mode, but at least 0.5 (1.25) W values in () for "FULL" video bandwidth setting	same als calculate mode, but at least 2 (5) W values in () for "FULL" video bandwidth setting	

	<i>Sensor</i>	R&S®NRT-Z14	R&S®NRT-Z43	R&S®NRT-Z44
Average burst power measurement^{3/4)} Video bandwidth setting in {}	Burst width (t)			
	Calculate mode	0.2 μs to 150 ms		0.2 μs to 150 ms
	Measure mode	500 μs to 150 ms {4 kHz} 10 μs to 150 ms {200 kHz} 2 μs to 150 ms {"FULL"}		500 μs to 150 ms {4 kHz} 10 μs to 150 ms {200 kHz} 1 μs to 150 ms {"FULL"}
	Repetition rate (1/T)	7/s min.		
	Duty cycle t/T			
	Calculate mode	as defined by burst width and repetition rate		
	Measure mode	0.01 to 1		
	Measurement uncertainty at 18 °C to 28 °C			
	Calculate mode	same as for average power measurement; stated zero offset multiplied by T/t		
	Measure mode	same as for calculate mode plus 2% of rdg (0.09 dB) at 0.1 duty cycle ¹⁷⁾		
	Temperature coefficient	same as for average power measurement		
Measurement time/ averaging factor¹⁶⁾				
Calculate mode	see average power measurement with corresponding average power value (average burst power multiplied by t/T)			
Measure mode with 0.1 duty cycle; values in () for high resolution setting	1.6 (9.5) s / 4 (32) 2 W to 20 W 0.75 (1.6) s / 1 (4) 20 W to 300 W	1.6 (9.5) s / 4 (32) 0.5 W to 5 W 0.75 (1.6) s / 1 (4) 5 W to 75 W	1.6 (9.5) s / 4 (32) 2 W to 20 W 0.75 (1.6) s / 1 (4) 20 W to 300 W	
Crest factor measurement	Definition	ratio of peak envelope power to average power in dB (only with 1 → 2 forward direction)		
	Power measurement range	see average power and peak envelope power specifications		
	Measurement uncertainty	approx. 4.3 dB × (measurement error of peak hold circuit in W divided by peak envelope power)		
	Measurement time/ averaging factor	see specifications for peak envelope power measurement with simultaneous reflection measurement		
Peak envelope measurement (PEP)³⁾ Video bandwidth settings in {}	Definition	peak value of carrier power (only with 1 → 2 forward direction)		
	Power measurement range			
	Burst signals (repetition rate 20/s min.)	0.4 W to 300 W from 100 μs width {4kHz} 1.0 W to 300 W from 2 μs width {200 kHz} 2.0 W to 300 W from 1.5 μs width {"FULL"}	0.1 W to 75 W from 100 μs width {4 kHz} 0.25 W to 75 W from 2 μs width {200 kHz} 0.5 W to 75 W from 0.2 μs width {"FULL"}	0.4 W to 300 W from 100 μs width {4 kHz} 1 W to 300 W from 2 μs width {200 kHz} 2 W to 300 W from 0.2 μs width {"FULL"}
	cdmaOne, WCDMA, CDMA2000®, DAB, DVB-T		1 W to 75 W {"FULL" with modulation correction switched on}	4 W to 300 W {"FULL" with modulation correction switched on}
	other signal type	see burst signal of equivalent burst width		
	Measurement uncertainty at 18 °C to 28 °C	same as average power measurement, plus measurement error of peak hold circuit		
	Measurement error limits of peak hold circuit for burst signals with specified burst width, repetition rate 100/s min., duty cycle 0.1 min.	±(3% of rdg + 0.05 W) ¹⁰⁾ from 200 μs {4 kHz} ±(3% of rdg + 0.2 W) ¹⁰⁾ from 4 μs {200 kHz} ±(7% of rdg + 0.4 W) ¹⁰⁾ from 2 μs {"FULL"}	±(3% of rdg + 0.012 W) ¹⁰⁾ from 200 μs {4 kHz} ±(3% of rdg + 0.05 W) ¹⁰⁾ from 4 μs {200 kHz} ±(7% of rdg + 0.1 W) ¹⁰⁾ from 1 μs {"FULL"}	±(3% of rdg + 0.05 W) ¹⁰⁾ from 200 μs {4 kHz} ±(3% of rdg + 0.2 W) ¹⁰⁾ from 4 μs {200 kHz} ±(7% of rdg + 0.4 W) ¹⁰⁾ from 1 μs {"FULL"}
	at repetition rates from 20/s to 100/s	add ±(1.6% of rdg + 0.15 W)	add ±(1.6% of rdg + 0.04 W)	add ±(1.6% of rdg + 0.15 W)
at duty cycles from 0.001 to 0.1	add ±0.10 W {200 kHz, "FULL"} add ±0.05 W {4 kHz}	add ±0.025 W {200 kHz, "FULL"} add ±0.013 W {4 kHz}	add ±0.10 W {200 kHz, "FULL"} add ±0.05 W {4 kHz}	
at burst width from 0.5 μs to 1 μs 0.2 μs to 0.5 μs		add ±5% of rdg add 10% of rdg		

		<i>Sensor</i>			
<i>Parameter</i>		R&S®NRT-Z14	R&S®NRT-Z43	R&S®NRT-Z44	
Peak envelope measurement (PEP) Video bandwidth setting in {}	Typ. measurement errors of peak hold circuit with spread-spectrum signals ¹⁸⁾		cdmaOne, DAB ¹²⁾ : ±(5% of rdg + 0.1 W) CDMA2000® (3X) ¹³⁾ , WCDMA ¹⁴⁾ , DVB-T: ±(15% of rdg + 0.1 W)	cdmaOne, DAB ¹²⁾ : ±(5% of rdg + 0.4 W) CDMA2000® (3X) ¹³⁾ , WCDMA ¹⁴⁾ , DVB-T: ±(15% of rdg + 0.4 W)	
	Temperature coefficient ¹⁵⁾	0.35 %/K (0.015 dB/K) 40 MHz to 1 GHz 0.50 %/K (0.022 dB/K) 25 MHz to 40 MHz	0.35 %/K (0.015 dB/K) 0.4 GHz to 4 GHz	0.35 %/K (0.015 dB/K) 0.3 GHz to 4 GHz 0.50 %/K (0.022 dB/K) 0.2 GHz to 0.3 GHz	
	Measurement time/averaging factor ¹⁶⁾ Values in () for high resolution setting	PEP measurement only ¹⁹⁾ (not possible in combination with the R&S®NRT) with simultaneous reflection measurement	0.28 (0.40) s / 1 (4) 0.40 (0.55) s / 4 (8) 0.7 (1.5) s / 1 (4) 1.5 (2.7) s / 4 (8)	{4 kHz, 200 kHz} {"FULL"} {4 kHz, 200 kHz} {"FULL"}	
Complementary cumulative distribution function measurement (CCDF)	Definition	probability in % of forward power envelope exceeding a specified threshold (only with 1 → 2 forward direction)			
	Measurement range	0% to 100%			
	Measurement uncertainty at 18 °C to 28 °C	0.2% ²⁰⁾			
	Threshold level range	1 W to 300 W	0.25 W to 75 W	1 W to 300 W	
	Accuracy of threshold level at 18 °C to 28 °C	±(5% of threshold level in W + 0.5 W)	±(5% of threshold level in W + 0.13 W)	±(5% of threshold level in W + 0.5 W)	
	Measurement time/averaging factor ¹⁶⁾ Values in () for high resolution setting	CCDF measurement only ¹⁹⁾ with simultaneous reflection measurement (not possible in combination with the R&S®NRT)	0.26 (0.37) s / 1 (4) 0.7 (1.6) s / 1 (4)		
Reflection measurement Values in {}: 3 GHz to 4 GHz	Definition	measurement of load match in terms of SWR, return loss or reflection coefficient			
	Reflection measurement range Return loss SWR Reflection coefficient	0 to 23 dB 1.15 to ∞ 0.07 to 1	0 dB to 23 {20} dB 1.15 {1.22} to ∞ 0.07 {0.10} to 1		
	Min. forward power	0.06 [0.3] W (specs met from 0.4 [2] W)	0.007 [0.07] W (specs met from 0.05 [0.5] W)	0.03 [0.3] W (specs met from 0.2 [2] W)	
	Measurement uncertainty	see diagram			
	Measurement time/averaging factor	same as measurement time of selected power measurement function, shortest with average power measurement			

Power measurement with R&S®NAP-Z sensors and option R&S®NRT-B1

Measurement channels	2 identical channels (for forward and reverse power) with same specifications
Range selection	automatic
Frequency response correction	with R&S®NAP-Z7 and R&S®NAP-Z8 under consideration of reported calibration factors
Zero adjustment	with RF level switched off, duration approx. 5 s
RF connectors	N male/N female (R&S®NAP-Z6: 7/16 male, 7/16 female)
Length of connecting cable	1.5 m
Length of extension cable	max. 25 m (R&S®NAP-Z2)
Dimensions (W × H × D)/weight	125 mm × 105 mm × 45 mm / 0.6 kg (R&S®NAP-Z6) 118 mm × 118 mm × 45 mm / 0.7 kg (R&S®NAP-Z7, R&S®NAP-Z8)

Specifications of Directional Power Sensors R&S®NAP-Z7/-Z8 outside the 1.5 MHz to 30 MHz frequency range (20 °C to 25 °C). Values in [] taking into account the reported calibration factors. Calibration interval: 1 year.

Frequency in MHz		0.2 to 0.4	0.4 to 1.5	30 to 50	50 to 80
Directivity ²⁾ in dB (min.)	R&S®NAP-Z7	–	23	30	20
	R&S®NAP-Z8	25	30	30	20
Uncertainty ²²⁾ for average power measurement, in % of rdg (max.)	R&S®NAP-Z7	–	35 [12]	11 [4]	25 [5]
	R&S®NAP-Z8	32 [15]	13 [6]	11 [4]	25 [5]

Specifications of the Directional Power Sensors R&S®NAP-Z6, R&S®NAP-Z7 and R&S®NAP-Z8

	<i>Sensor</i>	R&S®NAP-Z6	R&S®NAP-Z7	R&S®NAP-Z8	
General data (max. power see diagrams)	Parameter				
	Power measurement range ¹⁾	0.3 W to 1100 W	0.05 W to 200 W	0.5 W to 2000 W	
	Frequency range	25 MHz to 1 GHz	0.4 MHz to 80 MHz	0.2 (0.4 ²¹⁾) MHz to 80 MHz	
	SWR (referenced to 50 Ω)	1.07 max.	1.03 max. (1.02 max. from 1.5 MHz to 30 MHz)		
	Insertion loss up to 0.3 GHz up to 0.5 GHz whole frequency range	0.05 dB max. 0.10 dB max. 0.15 dB max.	– – 0.015 dB max.		
Directivity ²⁾	25 dB min.	35 dB min. (from 1.5 MHz to 30 MHz) other frequencies see table			
Average power measurement ³⁾	Measurement range ⁵⁾	0.3 W to 1100 W	0.05 W to 200 W	0.5 W to 2000 W	
	Measurement uncertainty ²²⁾ at 20 °C to 25 °C	6% max. of rdg, plus zero offset	6 [4] % max. of rdg ²⁴⁾ , plus zero offset (1.5 MHz to 30 MHz), other frequencies see table		
	Zero offset ¹⁰⁾	±0.04 W	±0.01 W	±0.1 W	
	Temperature coefficient	0.25 % / K max., to be considered outside temperature range 20 °C to 25 °C			
	Measurement time ²³⁾	0.4 s	0.5 s		
Peak envelope power measurement ³⁾	Measurement range		0.5 W to 200 W	5 W to 2000 W	
	AM Burst width t Repetition rate 1/T		30 Hz to 10 kHz 20 μs min. 30/s min.		
	Measurement uncertainty at 20 °C to 25 °C		same as for average power measurement plus measurement error of peak hold circuit		
	Error limits of peak hold circuit		±(2 (7) %) of rdg + 0.04 % of P _{nom} ²⁵⁾ for two superimposed CW carriers of equal amplitude, frequency offset 0.3 kHz to 3 kHz (0.03 kHz to 0.3 kHz and 3 kHz to 10 kHz)		
	Temperature coefficient		same as for average power measurement plus 0.003 % of P _{nom} ²⁵⁾ /K		
Measurement time ²³⁾		1.5 s			
Reflection measurement	Measurement range Return loss/SWR/reflection coefficient	0 dB to 23 dB / 1.15 to ∞ / 0.07 to 1 (30 MHz to 1 GHz)	0 dB to 28 dB / 1.08 to ∞ / 0.04 to 1 (1.5 MHz to 30 MHz)		
	Minimum forward power	3 W	0.5 W	5 W	
	Compliance with data sheet values for the following power values	20 W	10 W	100 W	
	Measurement uncertainty	see diagram – specifications apply only after zero adjustment and selection of average power measurement function			
	Measurement time	same as measurement time of selected power measurement function; shortest with average power measurement			

1) Dependent on measurement function.

2) Ratio of measured forward and reverse power in dB with perfectly matched load.

3) Specifications apply to measurement of forward power.

4) Values in []: 2 → 1 forward direction (if different from 1 → 2 forward direction).

5) Power measurement below the specified limits is possible at the expense of an increased influence of zero offset.

6) Measurement of average power up to the CW limits is possible at the expense of increased measurement errors.

7) Expanded uncertainty with a coverage factor of k = 2. For normal distribution, this coverage factor has a coverage probability of 95%.

8) With matched load (SWR 1.2 max.) under consideration of the carrier frequency which must be input to an accuracy of 1%, measurement results referenced to the load end of the sensor, averaging filter set to automatic mode (high resolution). The influence of the carrier harmonics can be ignored provided they are below –30 dBc up to 5 GHz. With an SWR of more than 1.2 on the load end, the influence of directivity on the measured forward power is to be considered. The associated expanded uncertainty with a coverage factor of k = 2 is equal to 6% of rdg (0.25 dB) × the load reflection coefficient. Example: A mismatched load with 3.0 SWR yields a 0.5 reflection coefficient, producing an additional uncertainty of 3% of rdg (0.13 dB). The overall measurement uncertainty will be increased to 4.4% of rdg (0.19 dB).

9) With matched load (SWR 1.2 max.) under consideration of the carrier frequency which must be input to an accuracy of 1%; measurement results referenced to the load end of the sensor, averaging filter set to automatic mode (high resolution). The influence of harmonics of the carrier can be neglected provided they are below –30 dBc up to 4 GHz, –35 dBc from 4 GHz to 10 GHz and –60 dBc above 10 GHz. With an SWR of more than 1.2 on the load end, the influence of directivity on measured forward power is to be considered. The associated expanded uncertainty with a coverage factor of k = 2 equals 6% of rdg (0.25 dB) × load reflection coefficient for carrier frequencies up to 3 GHz and 10% of rdg (0.4 dB) × load reflection coefficient from 3 to 4 GHz. Example: a mismatched load with 3.0 SWR yields a 0.5 reflection coefficient leading to an additional uncertainty of 3% of rdg (0.13 dB) in the frequency range up to 3 GHz. Overall measurement uncertainty will be increased to 4.4% of rdg (0.19 dB).

10) After zero adjustment.

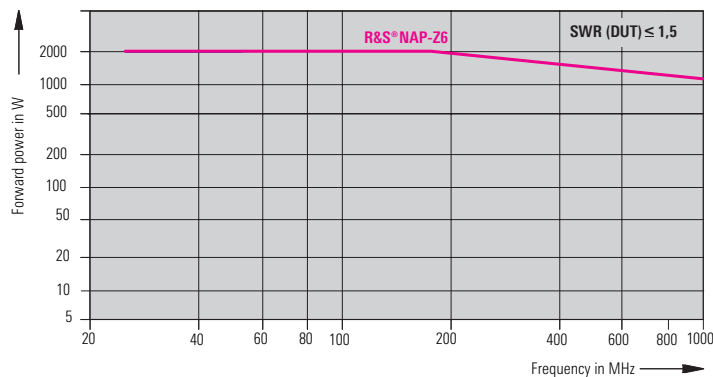

Maximum continuous power rating of the R&S® NAP-Z6 sensor (with modulated signals: peak envelope power (PEP))

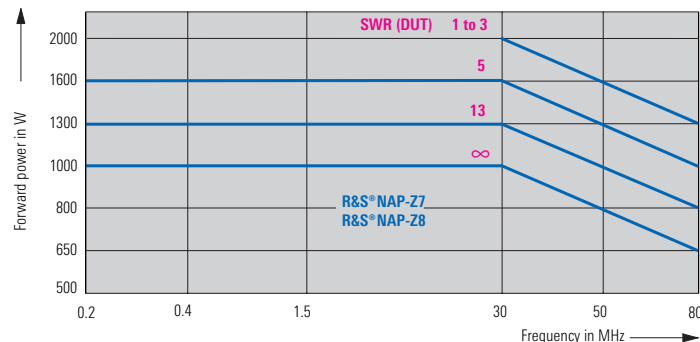

Maximum continuous power rating of the R&S® NAP-Z7 sensors and R&S® NAP-Z8 (with modulated signals: peak envelope power (PEP))

- 11) In temperature range 18 °C to 28 °C, relative to a CW signal. The error depends on the modulation parameters for each case, e.g. the modulation frequency with AM, and the individual sensor characteristics. The specified tolerances refer to 1 → 2 forward direction and a power of 30 W (R&S®NRT-Z43) or 120 W (R&S®NRT-Z44). With burst signals, the specified errors refer to an average burst power of 30 W (R&S®NRT-Z43) or 120 W (R&S®NRT-Z14/-Z44). Since errors due to modulation are proportional to power, they become smaller the lower the power: a WCDMA signal with an average power of 30 W, for example will only cause a very small error of about ±0.5% of the R&S®NRT-Z44 sensor with modulation correction switched on.
- 12) With modulation correction switched on.
- 13) With modulation correction switched on (same as WCDMA), chip rate set to 3.6864 Mc/s.
- 14) Signal similar to test model 1 with 64 channels for downlink with 3.84 Mc/s in line with 3GPP standard 3G TS 25.141 V3.1.0 (2000-03); modulation correction switched on, chip rate set according to test signal.
- 15) Statistically distributed with a mean value of 0%/K, the stated temperature coefficients corresponding to approximately two standard deviations. Temperature coefficients must be considered for calculation of measurement uncertainty below 18 °C and above 28 °C. Example: at +5 °C and 1 GHz a temperature drift of $(18 - 5) \times 0.25\% = 3.25\%$ of rdg (0.14 dB) for average power measurement can be expected relative to 18 °C. Combined with the measurement uncertainty of 3.2% at 18 °C to 28 °C the overall uncertainty will be 4.6% of rdg (0.19 dB).
- 16) Measurement results settled with power-dependent (automatic) averaging. Each measurement time is defined as the time from the input of the trigger command up to the termination of the return string (baud rate 38400). All measurement results consist of two measured values: one each for the forward power measurement function and for the selected reflection parameter (SWR, return loss, reflection coefficient or reflected power). When operated on the R&S®NRT, the specified measurement times increase by 0.05 s.
- 17) After zero adjustment, unmodulated burst signal with rectangular envelope. The burst power must be at least 1 W for the R&S®NRT-Z43 and at least 4 W for the R&S®NRT-Z14 and the R&S®NRT-Z44. For the R&S®NRT-Z43 and the R&S®NRT-Z44, the burst width must be >2 ms {4 kHz}, >40 μs {200 kHz} and >5 μs {"FULL"}. For the R&S®NRT-Z14, the burst width must be >2 ms {4 kHz}, >40 μs {200 kHz} and >10 μs {"FULL"}. Since the measurement uncertainty is inversely proportional to the burst width and the power, it may have smaller or higher values for other waveforms.
- 18) In temperature range 18 °C to 28 °C, video bandwidth "FULL", PEP defined as power with a CCDF value 10^{-6}.
- 19) Setting must be initiated with a "rev:pow" command in addition to the setting command for the forward measurement function via the remote interface of the sensor. Since the sensor measures average reverse power with this setting (a parameter normally not of interest in combination with any function other than average power measurement), the setting is denoted as "PEP measurement only" or "CCDF measurement only".
- 20) After zero adjustment, unmodulated burst signal with rectangular envelope, threshold value set to half the burst power. The burst power must be at least 1 W for the R&S®NRT-Z43 and at least 4 W for the R&S®NRT-Z44. For the R&S®NRT-Z43 and the R&S®NRT-Z44, the repetition rate must be <math><50/s</math> {4 kHz}, <math><2500/s</math> {200 kHz} and <math><20000/s</math> {"FULL"}. For the R&S®NRT-Z14, the repetition rate must be <math><50/s</math> {4 kHz}, <math><2500/s</math> {200 kHz} and <math><10000/s</math> {"FULL"}. Since the measurement uncertainty is proportional to the repetition rate and inversely proportional to the power, it may have smaller or higher values for other waveforms. For spread spectrum signals such as cdmaOne, CDMA2000®(3x), WCDMA, DAB and DVB-T, the measurement uncertainty is optimally described by an uncertainty for the threshold setting. This uncertainty is taken into account in addition to the specified value. With modulation correction switched on, this additional uncertainty is approx. 5% of the power value in W for the aforementioned standards.
- 21) 0.4 MHz only with PEP measurement.
- 22) With matched load (SWR 1.2 max.), test signal with unmodulated envelope (CW, FM, φM, FSK, GMSK or similar), measurement results referenced to the load end of the sensor. The maximum uncertainty specified in the table is roughly equal to the expanded uncertainty with a coverage factor of $k=2$. With an SWR of more than 1.2 on the load end, the influence of directivity on measured forward power is to be considered. The associated expanded uncertainty in percent with a coverage factor of 2 is equal to $6\% \times$ the reflection coefficient of the load at a directivity of 30 dB. Example: A mismatched load with 3.0 SWR yields a 0.5 reflection coefficient, producing an additional uncertainty of $6 \times 0.5\% = 3\%$.
- 23) Measurement results settled.
- 24) Values in [] taking into consideration the calibration factors determined for the sensor.
- 25) Upper limit of the power range.

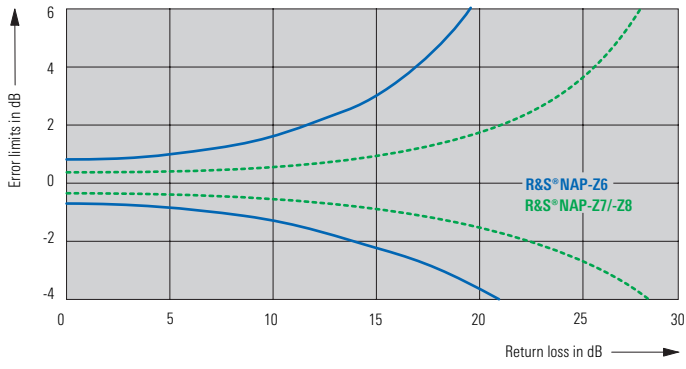

Measurement error limits (two standard deviations) for reflection measurements with the Directional Power Sensors R&S® NAP-Z6, R&S® NAP-Z7 and R&S® NAP-Z8 (with the latter two having a limited frequency range from 1.5 MHz to 30 MHz); min. forward power: see specifications for the power sensors

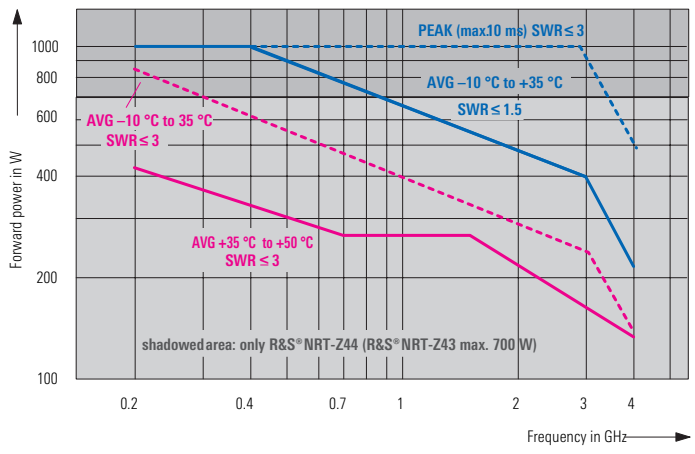

Maximum forward power of the Directional Power Sensors R&S® NRT-Z43 and R&S® NRT-Z44 (for both directions)

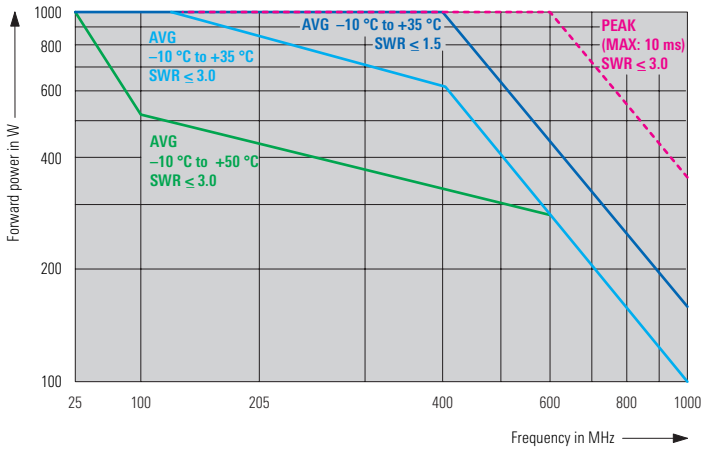

Maximum forward power of the Directional Power Sensor R&S® NRT-Z14 (for both directions)

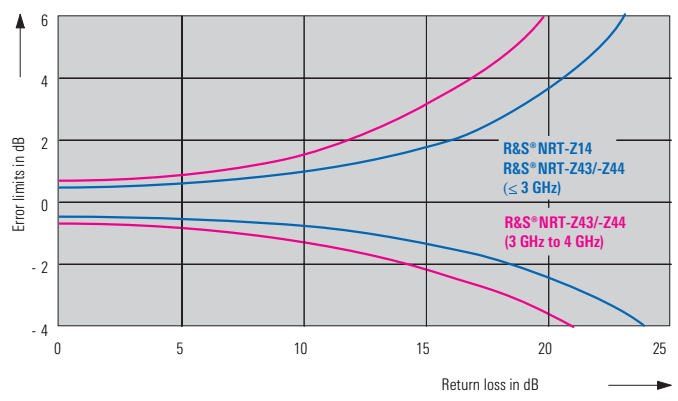

Measurement error limits (two standard deviations) for reflection measurements with the Directional Power Sensors R&S® NRT-Z14, R&S® NRT-Z43 and R&S® NRT-Z44; min. forward power (forward direction 1 → 2):
 0.4 W for the R&S® NRT-Z14
 0.05 W for the R&S® NRT-Z43
 0.2 W for the R&S® NRT-Z44

R&S®NRT base unit

Frequency range	200 kHz to 4 GHz ¹⁾
Power measurement range	0.7 mW to 2 kW ¹⁾
Measurement inputs for R&S®NRT-Z sensors	1 to 3 (4), one active one input on front panel, two additional inputs on rear panel (option R&S®NRT-B2)
for R&S®NAP-Z sensors	one input on rear panel (option R&S®NRT-B1)
Measurement functions	
Power	forward power and power absorbed by the load in W, dBm, dB or % (dB and % referenced to measured value or reference value)
Power parameters ¹⁾	average power, average burst power, peak envelope power, peak-to-average ratio (crest factor), complementary cumulative distribution function
Reflection	SWR, return loss, reflection coefficient, reverse-to-forward power ratio in %, reverse power
Frequency response correction	upon input of RF frequency, the stored correction factors of the power sensor being taken into account; for R&S®NAP-Z sensors the R&S®NRT base unit offers memory for 3 sets of calibration factors
Zero adjustment	selectable with RF power switched off, duration approx. 5 s
Measurement uncertainty	see sensor specifications
Display	LCD
Digital	simultaneous indication of power, reflection, and carrier frequency (input value)
Resolution	HIGH: 4½ digits (0.001 dB) LOW: 3½ digits (0.01 dB)
Analog	two 50-element bargraphs for indication of power and reflection with selectable or pre-defined scale-end values
Averaging	automatic, depending on selected resolution and sensor characteristics
Max/Min	display of current maximum, minimum or difference value (Max – Min) for the selected measurement functions
Remote control	to SCPI-1995.0 command set
IEC/IEEE bus	to IEC 625 (IEEE 488); interface functions SH1, AH1, T6, L4, SR1, RL1, PP1, DC1, DT1
Serial interface	9-pin D-Sub connector to EIA-232E; 1200/2400/4800/9600 baud; RTS/CTS or XON/XOFF handshake selectable
Measurement time with R&S®NAP-Z sensors with R&S®NRT-Z sensors	see R&S®NAP-Z specifications add 0.05 s to R&S®NRT-Z sensor specifications
AUX connector	BNC connector as signaling output or trigger input (TTL)
Beeper	for SWR monitoring (power and SWR threshold selectable) and acoustic echoing of keystrokes
Setups	last setting, default setting and up to four user-defined instrument settings

Options	
R&S®NRT-B1	for measurement with one R&S®NAP-Z sensor at the rear
R&S®NRT-B2	two additional R&S®NRT-Z sensor inputs at the rear
R&S®NRT-B3	battery supply with built-in charger and NiMH battery
Calibration interval	3 years, only in conjunction with option R&S®NRT-B1; no calibration required for R&S®NRT base unit and the other options
General data	
AC power supply	IEC connector for single-phase AC voltage of 90 V to 264 V, 47 Hz to 63 Hz or 90 V to 132 V, 47 Hz to 440 Hz; 35 VA, max. 0.4 A
Battery supply	with option R&S®NRT-B3, operating time approx. 8 h with one R&S®NRT-Z power sensor and option R&S®NRT-B1; recharging within 2 hours by quick-charge management; switch-on time selectable; battery can be exchanged without opening the instrument
Dimensions (W × H × D)	219 mm × 103 mm × 240 mm
Weight	3.5 kg with all options

1) Sensor-dependent.

Directional Power Sensors R&S®NRT-Z14/-Z43/-Z44

Measurement channels	2 (for forward and reverse power)
Forward direction 1 → 2 2 → 1	standard for all measurement functions only for measurement of average and average burst power (at lower levels)
Measurement functions	forward power and reflection
Power parameters	average power, average burst power, peak envelope power, peak-to-average ratio, complementary cumulative distribution function
Reflection	return loss, SWR, reflection coefficient, reverse-to-forward power ratio in %, reverse power
Range selection	automatic
Video bandwidth	4 kHz, 200 kHz and "FULL" (600 kHz for the R&S®NRT-Z14, 4 MHz for the R&S®NRT-Z43/-Z44) for all power parameters except for the measurement of the average power
Frequency response correction	upon input of RF frequency, the stored correction factors of both measurement channels being taken into account
Zero adjustment	upon remote command with RF level switched off, duration approx. 5 s
RF connectors	N (female) on both ends
Remote control	via serial RS-422 interface, 4.8/9.6/19.2 or 38.4 kbaud, XON/XOFF handshake, SCPI-like command set; LEMOSA 6-pin, size 2 plug for RXD/TXD cable pairs and power supply (see following page)
Calibration interval	2 years

Directional Power Sensors R&S®NRT-Z14/-Z43/-Z44 (continued)

General data	
Power supply	6.5 V to 28 V, approx. 1.5 W
Length of connecting cable	1.5 m
Max. length of extension cable	500 m with 12 V supply voltage (via R&S®NRT-Z3, R&S®NRT-Z4 or line-operated R&S®NRT) 30 m with 7 V supply voltage (battery-operated R&S®NRT)
Dimensions (W × H × D)	120 mm × 95 mm × 39 mm
Weight	0.65 kg

RS-232 Interface Adapter R&S®NRT-Z3

Power supply	90 V to 264 V, 47 Hz to 63 Hz via supplied plug-in power supply with adapter for all AC supply standards (Euro, UK, USA, Australia)
RS-232 interface	9-pin D-Sub female connector
Length of connecting cable	approx. 1.3 m
Weight	0.3 kg (adapter); 0.1 kg (power supply)
Operating temperature range	0 °C to +50 °C

PC Card Interface Adapter R&S®NRT-Z4

Compatibility	PCMCIA Release 2.1, card type II (5 mm thick)
Current drain	350 mA (with sensor connected) at 5 V (approx. 10% of power consumption of commercial laptops)
Required system	PC with PC Card slot, operating system Win 98 / NT / 2000 / ME / XP
Length of connecting cable	approx. 2 m
Weight	0.25 kg
Operating temperature range	0 °C to +50 °C

Environmental conditions for R&S®NRT and Directional Power Sensors R&S®NRT-Z and R&S®NAP-Z

Temperature loading	to EN 60068-2-1, EN 60068-2-2 and MIL-T-28800D, class 5
Permissible temperature range	−10 °C to +55 °C
Operating temperature range	0 °C to +50 °C (unless otherwise stated)
Storage temperature range	−40 °C to +71 °C
Climatic resistance	95% rel. humidity, cyclic test at +25 °C/+40 °C (without condensation) to EN 60068-2-30
Mechanical resistance	
Vibration, sinusoidal	5 Hz to 55 Hz, max. 2 g; 55 Hz to 150 Hz, 0.5 g constant; to EN 60068-2-6, EN 61010-1 and MIL-T-28800 D
Vibration, random	10 Hz to 500 Hz, 1.9 g (rms) to EN 60068-2-64
Shock	40 g shock spectrum to MIL-STD-810 C, EN 60068-2-27 and MIL-T-28800 D, class 5

Environmental conditions for R&S®NRT and Directional Power Sensors R&S®NRT-Z and R&S®NAP-Z (continued)

Electromagnetic compatibility	to EN 61326-1, EN 55011 and MIL-STD-461C, CE03, RE02, CS02 and RS03 (with raised field strength of 20 V/m)
Safety	to EN 61010-1

Ordering information

Base unit			
Power Reflection Meter	R&S®NRT		1080.9506.02
Directional Power Sensors R&S®NRT-Z (incl. demo software)			
120 (300) W	25 MHz to 1 GHz	R&S®NRT-Z14	1120.5505.02
30 (75) W	0.4 GHz to 4 GHz	R&S®NRT-Z43	1081.2905.02
120 (300) W	0.2 GHz to 4 GHz	R&S®NRT-Z44	1081.1309.02
Directional Power Sensors R&S®NAP-Z			
1100 W	25 MHz to 1000 MHz	R&S®NAP-Z6	0392.7316.56
200 W	0.4 MHz to 80 MHz	R&S®NAP-Z7	0350.8214.02
2000 W	0.2 MHz to 80 MHz	R&S®NAP-Z8	0350.4619.02
Options			
Interface for Directional Power Sensors R&S®NAP-Z	R&S®NRT-B1		1081.0902.02
Two Rear Inputs for Directional Power Sensors R&S®NRT-Z	R&S®NRT-B2		1081.0702.02
Battery Supply with Built-In Charger and NiMH Battery	R&S®NRT-B3		1081.0502.02
Recommended extras			
NiMH Battery	R&S®NRT-Z1		1081.1209.02
Extension Cable for Directional Power Sensors R&S®NRT-Z			
10 m	R&S®NRT-Z2		1081.2505.10
30 m	R&S®NRT-Z2		1081.2505.30
for Directional Power Sensors R&S®NAP-Z			
25 m	R&S®NAP-Z2		0392.5813.02
RS-232 Interface Adapter for Directional Power Sensors R&S®NRT-Z including AC Power Supply	R&S®NRT-Z3		1081.2705.02
PC Card Interface Adapter for Directional Power Sensors R&S®NRT-Z	R&S®NRT-Z4		1120.5005.02
Carrying Bag with Straps and Pocket for Accessories	R&S®ZZT-222		1001.0500.00
19" Rack Adapter	R&S®ZZA-97		0827.4527.00

CDMA2000® is a registered trademark of the Telecommunications Industry Association (TIA-USA).

Certified Quality Management

ISO 9001

Certified Environmental Management

ISO 14001

More information at
www.rohde-schwarz.com
(search term: NRT)



ROHDE & SCHWARZ

www.rohde-schwarz.com

Europe, Africa, Middle East: +49 89 4129 12345, customersupport@rohde-schwarz.com

North America: +1 888 837 87 72, customer.support@rsa.rohde-schwarz.com

Latin America: +1 410 910 79 88 customersupport@la.rohde-schwarz.com

Asia: +65 65 130 488, customersupport.asia@rohde-schwarz.com

China: +86 800 810 82 28, customersupport.china@rohde-schwarz.com