

E4990A Impedance Analyzer

20 Hz to 10/20/30/50/120 MHz



This document provides technical specifications for the E4990A.

Options

The following options are available.

E4990A-120 20 Hz to 120 MHz

E4990A-050 20 Hz to 50 MHz

E4990A-030 20 Hz to 30 MHz

E4990A-020 20 Hz to 20 MHz

E4990A-010 20 Hz to 10 MHz

E4990A-001 Enhanced measurement speed (option 010/020/030/050 only).

Definitions

Specification (spec.):

Warranted performance. All specifications apply at 23 °C (± 5 °C), unless otherwise stated, and 90 minutes after the instrument has been turned on. Specifications include guard bands to account for the expected statistical performance distribution, measurement uncertainties, and changes in performance due to environmental conditions.

Typical (typ.):

Expected performance of an average unit which does not include guardbands. It is not covered by the product warranty.

General characteristics:

A general, descriptive term that does not imply a level of performance.

Basic Measurement Characteristic

Measurement parameters

Impedance parameters	$ Z $, θ_z , $ Y $, θ_y , Cp, Cs, Lp, Ls, Rp, Rs (R), D, Q, X, G, B, Complex Z, Complex Y
Level monitor	Vac, Iac, Vdc, Idc

Measurement terminal

Configuration	Four-terminal pair configuration
Connector type	Four BNC (female) connectors. Option 120: Can be converted to one port terminal using the Keysight Technologies, Inc. 42942A Terminal Adapter (7-mm port) or 42941A Impedance Probe (SMA (f) port).

Source Characteristics

Frequency

Range	20 Hz to 120 MHz (Option 120) 20 Hz to 50 MHz (Option 050) 20 Hz to 30 MHz (Option 030) 20 Hz to 20 MHz (Option 020) 20 Hz to 10 MHz (Option 010)
Resolution	1 mHz
Accuracy	
without Option 1E5	± 7 ppm ± 1 mHz (at 23 ± 5 °C)
with Option 1E5	± 1 ppm ± 1 mHz (at 23 ± 5 °C)
Stability	
without Option 1E5	± 7 ppm (at 5 to 40 °C, Typical)
with Option 1E5	± 0.5 ppm (at 5 to 40 °C, Typical) ± 0.5 ppm per year (Typical)

Voltage Signal Level

Range	5 mVrms to 1 Vrms
Resolution	1 mV
Accuracy	
at four-terminal pair port of the E4990A or 7-mm port of the 42942A	$\pm [(10 + 0.05 \times f)\% + 1 \text{ mV}]$
at measurement port of the 42941A, 16048G/H	$\pm [(15 + 0.1 \times f)\% + 1 \text{ mV}]$

NOTE

f : frequency [MHz].

These characteristics apply when OPEN is connected to each port.

Test signal level should be ≤ 0.5 Vrms when the measured impedance is $\leq 50 \Omega$.

Beyond $23 \pm 5 \text{ }^\circ\text{C}$ of temperature, test signal level setting accuracy is twice as bad as described.

Current Signal Level

Range	200 μArms to 20 mArms
Resolution	20 μA
Accuracy	
at four-terminal pair port of the E4990A	
at ≤ 15 MHz	$+ [10\% + 50 \mu\text{A}], - [(10 + 0.2 \times f^2)\% + 50 \mu\text{A}]$ (typical)
at > 15 MHz	$\pm [(10 + 0.3 \times f)\% + 50 \mu\text{A}]$ (typical)
at 7-mm port of the 42942A	
at ≤ 5 MHz	$+ [10\% + 50 \mu\text{A}], - [(10 + 1 \times f^2)\% + 50 \mu\text{A}]$ (typical)
at > 5 MHz	$\pm [(10 + 0.3 \times f)\% + 50 \mu\text{A}]$ (typical)
at measurement port of the 42941A, 16048G/H	
at ≤ 5 MHz	$+ [10\% + 50 \mu\text{A}], - [(15 + 1.5 \times f^2)\% + 50 \mu\text{A}]$ (typical)
at > 5 MHz	$\pm [(20 + 0.3 \times f)\% + 50 \mu\text{A}]$ (typical)

NOTE

f : frequency [MHz].

These characteristics apply when SHORT is connected to each port.

Test signal level should be ≤ 20 mArms when the measured impedance is $\leq 50 \Omega$.

Signal Level Monitor

Voltage range	(Same as the voltage signal level setting range)
Voltage monitor accuracy	
at four-terminal pair port of the E4990A or 7-mm port of the 42942A	$\pm (10 + 0.05 \times f + 100/Z_x)[\%]$ (typical)
at measurement port of the 42941A, 16048G/H	$\pm (10 + 0.15 \times f + 100/Z_x)[\%]$ (typical)
Current range	(Same as the current signal level setting range)
Current monitor accuracy	
at four-terminal pair port of the E4990A or 7-mm port of the 42942A	$\pm (10 + 0.3 \times f + Z_x/100)[\%]$ (typical)
at measurement port of the 42941A, 16048G/H	$\pm (10 + 0.4 \times f + Z_x/100)[\%]$ (typical)

NOTE

f : frequency [MHz], Z_x : impedance measurement value [Ω].

Beyond 23 ± 5 °C, the test signal level monitor accuracy is twice as bad as described.

Output Impedance

Output impedance	25 Ω (nominal)
------------------	-----------------------

DC Bias Function

DC voltage bias	
Range	0 to ± 40 V (see Figure 1)
Resolution	1 mV
Accuracy	$\pm [0.1\% + (5 + 30 \times I_{\text{mon}}) \text{ mV}]$ $\pm [0.2\% + (10 + 30 \times I_{\text{mon}}) \text{ mV}]$ (beyond 23 ± 5 °C)
DC current bias	
Range	0 to ± 100 mA (see Figure 1)
Resolution	40 μA
Accuracy	$\pm [2\% + (0.2 + V_{\text{mon}} /20) \text{ mA}]$ $\pm [4\% + (0.4 + V_{\text{mon}} /20) \text{ mA}]$ (beyond 23 ± 5 °C)
DC voltage bias at constant voltage mode	
Range	0 to ± 40 V (see Figure 1)
Resolution	1 mV
Accuracy	$\pm [0.5\% + (5 + Z_d \times I_{\text{mon}}) \text{ mV}]$ (typical) $\pm [1.0\% + (10 + Z_d \times I_{\text{mon}}) \text{ mV}]$ (beyond 23 ± 5 °C, typical)
DC current bias at constant current mode	
Range	0 to ± 100 mA (see Figure 1)
Resolution	40 μA
Accuracy	$\pm [1\% + (0.5 + V_{\text{mon}} /10000) \text{ mA}]$ (typical) $\pm [2\% + (1.0 + V_{\text{mon}} /5000) \text{ mA}]$ (beyond 23 ± 5 °C, typical)
DC bias monitor	
DC voltage range	(Same as the dc voltage bias setting range)
DC voltage accuracy	$\pm [0.2\% + (5 + Z_d \times I_{\text{mon}}) \text{ mV}]$ $\pm [0.4\% + (10 + Z_d \times I_{\text{mon}}) \text{ mV}]$ (beyond 23 ± 5 °C)
DC current range	(Same as the dc voltage bias setting range)
DC current monitor accuracy	$\pm [1\% + (0.5 + V_{\text{mon}} /10000) \text{ mA}]$ $\pm [2\% + (1.0 + V_{\text{mon}} /5000) \text{ mA}]$ (beyond 23 ± 5 °C)
Output impedance	25 Ω (nominal)

NOTE

V_{mon} : DC voltage bias monitor reading value [mV]

I_{mon} : DC current bias monitor reading value [mA]

Z_d = 0.3 (at four-terminal pair port of the E4990A, adapter setup: NONE)

Z_d = 2.0 (at test port of the 42941A, adapter setup: 42941A Impedance Probe)

Z_d = 0.5 (at 7-mm port of the 42942A, adapter setup: 42942A Terminal Adapter)

Z_d = 1.0 (at measurement port of the 16048G, adapter setup: four-terminal pair 1 m)

Z_d = 1.5 (at measurement port of the 16048H, adapter setup: four-terminal pair 2 m)

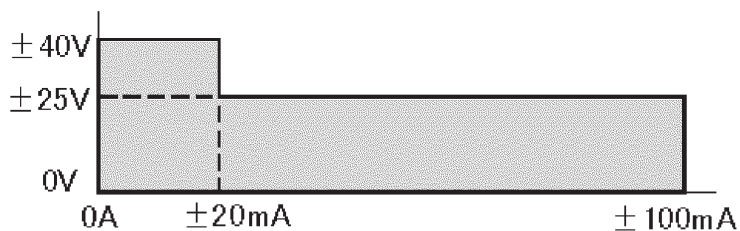

Figure 1. DC bias range

Sweep Characteristics

Available sweep parameters	Frequency, signal voltage, signal current, DC bias voltage, DC bias current
Sweep type	Linear frequency, log frequency, OSC level (voltage, current), DC bias (voltage, current), log DC bias (voltage, current)
Sweep direction	Up sweep, down sweep
Number of measurement points	2 to 1601 points
Segment sweep	
Available setup parameters for measurement points, Signal each segment	Sweep frequency range, number of level (voltage or current), DC bias (voltage or current), measurement time, point averaging factor, segment time, segment delay
Number of segments	1 to 201
Sweep span type	Order base or frequency base
Delay time	
Type	Point delay, sweep delay, segment delay or DC bias delay
Range	0 sec to 30 sec
Resolution	1 msec

Trigger Function

Trigger type	Continuous, single, averaging
Trigger source	Internal (free run), external (BNC connector input), GPIB/USB/LAN, manual (Front key)
Trigger event type	Point trigger, Sweep trigger

Measurement Time/Averaging

Measurement time	
Range	1 (fast) to 5 (precise), 5 steps
Averaging	
Type	Sweep-to-sweep averaging, point averaging
Averaging factor	1 to 999 (integer)

Measurement Time

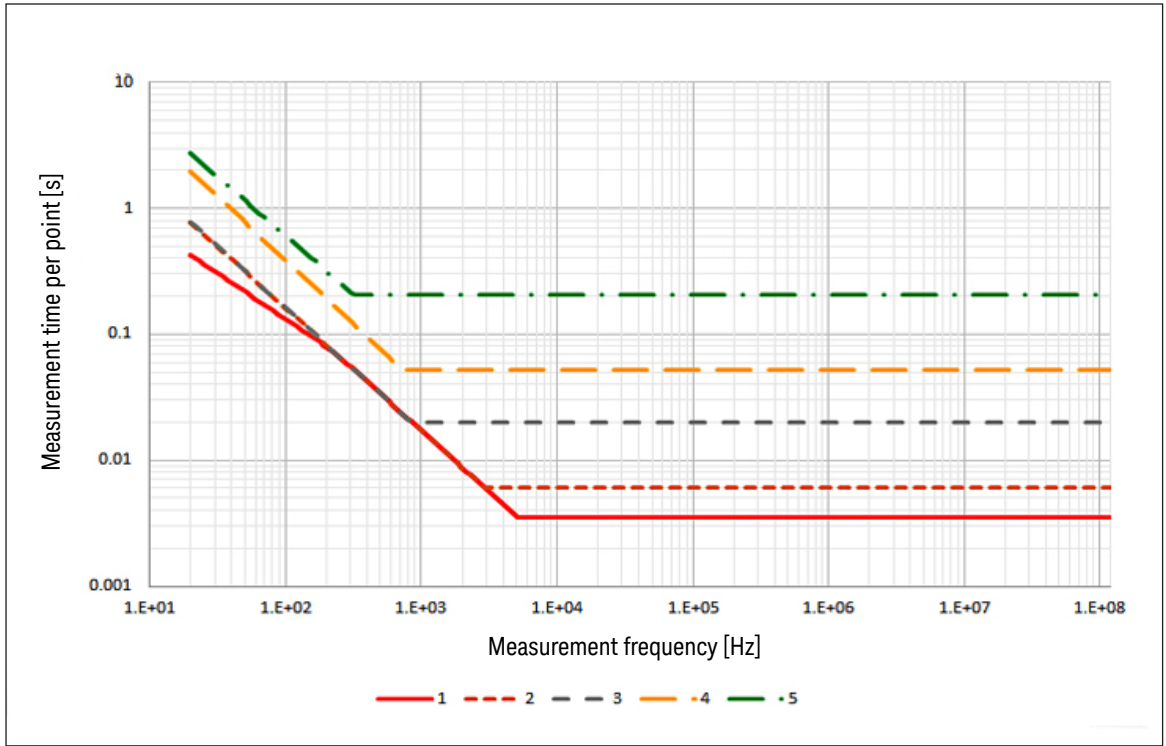

Figure 2. Measurement time (Option 050/ 030/ 020/ 010 with Option 001 or Option 120, adapter: None, 1 m, 2m, Typical)

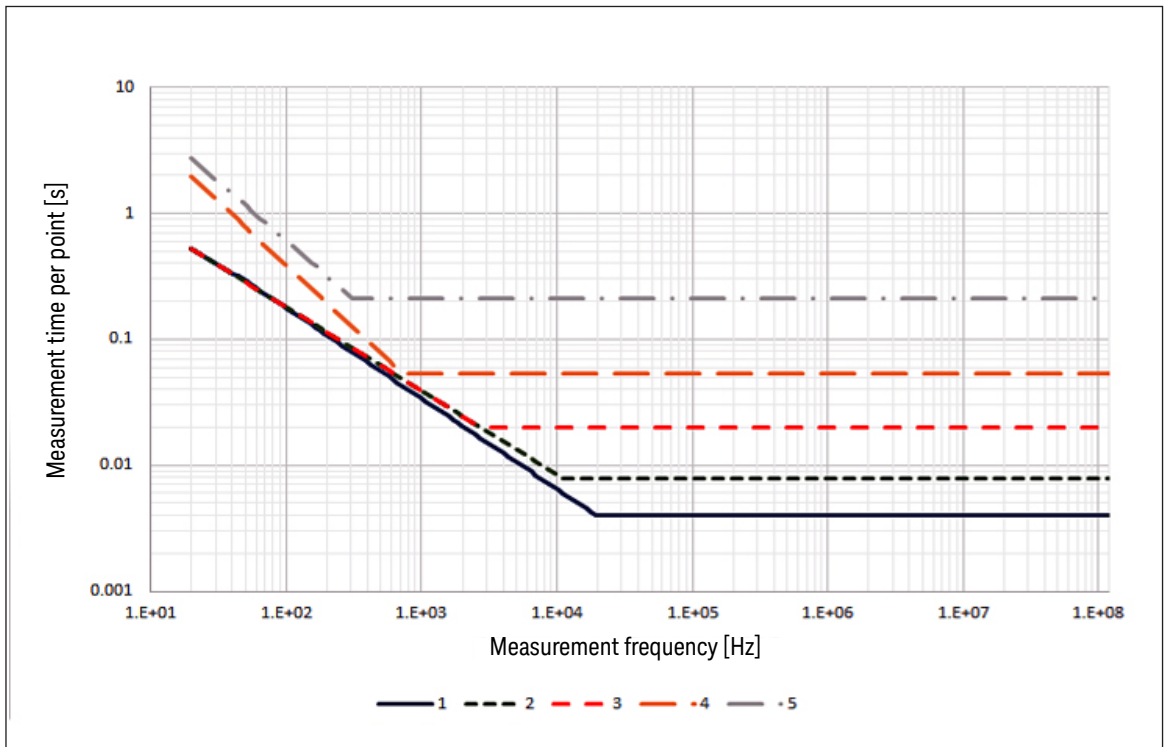

Figure 3. Measurement time (Option 120, adapter: 7mm 42942A/probe 42941A, Typical)

Measurement Time (continued)

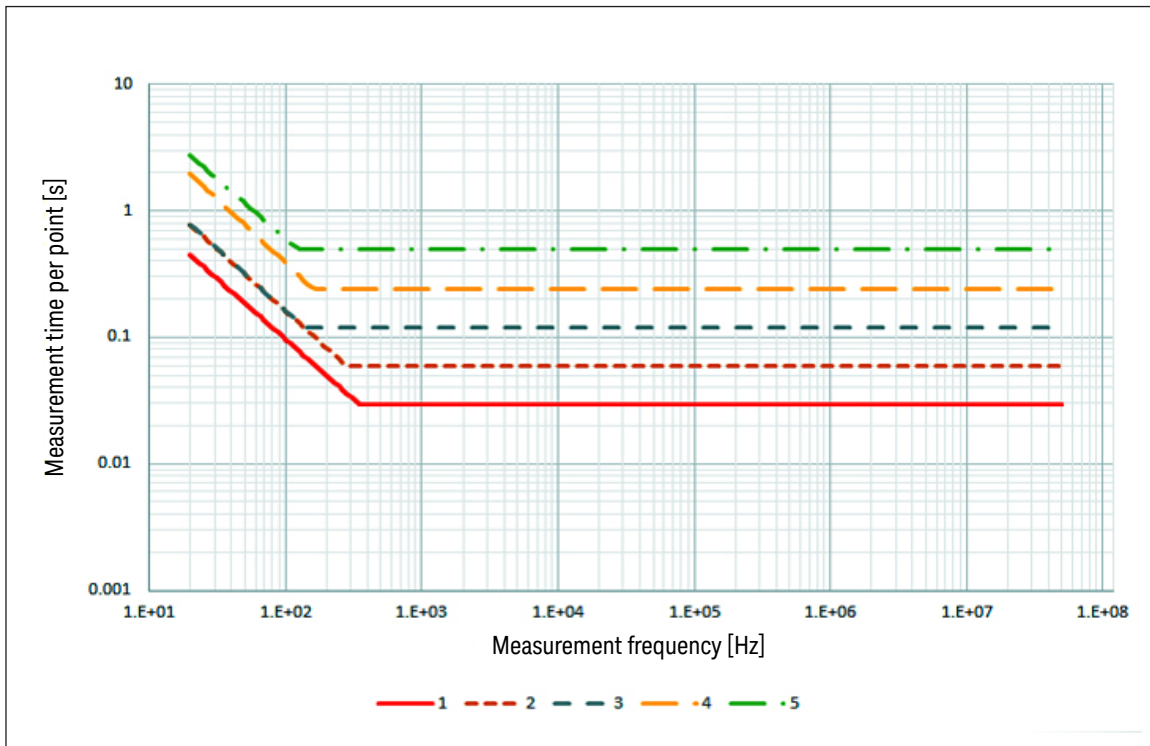

Figure 4. Measurement time (Option 050/ 030/ 020/ 010 without option 001, Typical)

Adapter Setup

Adapter selection	
NONE	No adapter (the 16047E, etc. direct connection type test fixture is connected)
4TP 1M	Four-terminal pair 1 m (16048G)
4TP 2M	Four-terminal pair 2 m (16048H)
7-mm 42942A ¹	Terminal adapter (42942A)
Probe 42941A ¹	Impedance probe (42941A)

1. Option 120 only.

Calibration

Calibration	
User calibration	Calibration performed with user-defined calibration kit (OPEN, SHORT, LOAD)
Port extension	Compensation performed when the measurement terminal is expanded from the 7-mm connector of the 42942A Terminal Adapter or the test port of the 42941A Impedance Probe. Enter electrical length or delay time for the extension.
Fixture compensation	Compensation performed at the device contacts of the test fixture using OPEN, SHORT, LOAD.
Calibration points	Fixed points, or User points determined by sweep setups

Measurement Accuracy

Conditions of accuracy

Temperature	
Four-terminal pair port of the E4990A's front panel	23 ± 5 °C Beyond 23 ± 5 °C, the measurement accuracy is twice as bad as described.
Measurement terminal of the 16048G or 16048H	Within ± 5 °C from the adapter setup temperature. Measurement accuracy applies when the adapter setup is performed at 23 ± 5 °C. When the adapter setup is performed beyond 23 ± 5 °C, the measurement accuracy is twice as bad as described.
7-mm port of the 42942A terminal adapter	Within ± 5 °C from the adapter setup temperature. Measurement accuracy applies when the adapter setup is performed at 23 ± 5 °C. When the adapter setup is performed beyond 23 ± 5 °C, the measurement accuracy is twice as bad as described.
Test port of the 42941A impedance probe	Within ± 5 °C from the adapter setup temperature. Measurement accuracy applies when the adapter setup is performed at 23 ± 5 °C. When the adapter setup is performed beyond 23 ± 5 °C, the measurement accuracy is twice as bad as described.

Measurement accuracy

Z , Y accuracy	± E [%] (see equation 1 on page 11, Equation 2 on page 14, equation 3 on page 17)
θ accuracy	± E/100 [rad]
L, C, X, B accuracy	
at Dx ≤ 0.1	± E [%]
at Dx > 0.1	± E × √(1 + Dx ²) [%]
R accuracy	
at Dx ≤ 0.1 (Qx ≥ 10) and Dx > E/100	Rp: ± $\frac{E}{D_x \mp E/100}$ [%] Rs: ± E/Dx [%]
at 0.1 < Dx < 10 (0.1 < Qx < 10)	Rp: ± E × $\frac{\sqrt{1 + D_x^2}}{D_x \mp \frac{E}{100} \times \sqrt{1 + D_x^2}}$ [%] Rs: ± E × $\frac{\sqrt{1 + D_x^2}}{D_x}$ [%]
at Dx ≥ 10 (Qx ≤ 0.1)	± E [%]
D accuracy	
at Dx ≤ 0.1	± E/100
at 0.1 < Dx ≤ 1	± E × (1 + Dx)/100
Q accuracy (at Qx × Da < 1)	
at Qx ≤ 10 (Dx ≥ 0.1)	± $\frac{Q_x^2 \times E (1 + D_x)/100}{1 \mp Q_x \times E (1 + D_x)/100}$
at Qx > 10 (Dx < 0.1)	± $\frac{Q_x^2 \times E/100}{1 \mp Q_x \times E/100}$
G accuracy	
at Dx > 0.1	± E × $\frac{\sqrt{1 + D_x^2}}{D_x}$ [%]
at Dx ≤ 0.1	± E/Dx [%]

NOTE

D_x : measurement value of D.

Q_x : measurement value of Q.

D_a : measurement accuracy of D.

Under an AC magnetic field, the following equation is applied to the measurement accuracy.

E × (1 + B × (5 + 500/V_{mv})) [%] (Typical)

B : Magnetic flux density [Gauss]

Impedance measurement accuracy at four-terminal pair port

Equation 1 shows the impedance measurement accuracy [%] at four-terminal pair port of the E4990A, or measurement port of the 16048G/16048H.

Equation 1. Impedance measurement accuracy [%] at four-terminal pair port (Typical at > 10 MHz)

$$E = E_p' + \left(\frac{Z_s'}{|Z_x|} + Y_o' \times |Z_x| \right) \times 100$$

Where,

$$E_p' = E_{pl} + E_{pbw} + E_{posc} + E_p \text{ [%]}$$

$$Y_o' = Y_{ol} + K_{bw} \times K_{yosc} \times (Y_{odc} + Y_o) \text{ [S]}$$

$$Z_s' = Z_{sl} + K_{bw} \times K_{zosc} \times Z_s \text{ [\Omega]}$$

E_{pl} [%]	1m: $0.02 + 2 \times f/100$ 2m: $0.02 + 3 \times f/100$
E_{pbw} [%]	Meas Time 5: 0 Meas Time 4: 0.06 at < 50 kHz, 0.03 at ≥ 50 kHz Meas Time 3: 0.2 at < 50 kHz, 0.1 at ≥ 50 kHz Meas Time 2: 0.4 at < 50 kHz, 0.2 at ≥ 50 kHz Meas Time 1: 0.8 at < 50 kHz, 0.4 at ≥ 50 kHz
E_{posc} [%]	$V_{osc} > 500$ mV: $0.018 \times (1000/V_{mv} - 1) + f/100$ 200 mV < $V_{osc} \leq 500$ mV: $0.018 \times (500/V_{mv} - 1)$ 100 mV < $V_{osc} \leq 200$ mV: $0.018 \times (200/V_{mv} - 1)$ $V_{osc} \leq 100$ mV: $(100/V_{mv} - 1) \times (0.018 + E_{pbw})$
E_p [%]	20 Hz $\leq f_m < 100$ Hz: 0.5 100 Hz $\leq f_m \leq 800$ Hz: 0.3 800 Hz < $f_m \leq 1$ MHz: 0.075 1 MHz < $f_m \leq 15$ MHz: $0.1 \times f$ 15 MHz < $f_m \leq 120$ MHz: 1.5
Y_{ol} [S]	1 m (16048G): $500n \times f/100$ 2 m (16048H): $1\mu \times f/100$
K_{bw}	Meas Time 5: 1 Meas Time 4: 1 Meas Time 3: 3 at ≤ 1 MHz, 4 at > 1 MHz Meas Time 2: 4 at ≤ 1 MHz, 5 at > 1 MHz Meas Time 1: 6 at ≤ 1 MHz, 10 at > 1 MHz
K_{yosc}	$V_{osc} > 500$ mV: $1000/V_{mv}$ $V_{osc} \leq 500$ mV: $500/V_{mv}$
Y_{odc} [S]	DCI range 1 mA: 0 DCI range 10 mA: 1μ DCI range 100 mA: 10μ

Impedance measurement accuracy at four-terminal pair port (continued)

Y_o [S]	$20 \text{ Hz} \leq f_m < 100 \text{ Hz}$: 10 n $100 \text{ Hz} \leq f_m \leq 200 \text{ kHz}$: 2.5 n $200 \text{ kHz} < f_m \leq 1 \text{ MHz}$: 5 n $1 \text{ MHz} < f_m \leq 15 \text{ MHz}$: 50 n $15 \text{ MHz} < f_m \leq 120 \text{ MHz}$: 500 n
Z_{sl} [Ω]	0 m: 0 1 m (16048G), 2 m (16048H): $20 \text{ Hz} \leq f_m < 500 \text{ Hz}$: 5 m $500 \text{ Hz} \leq f_m \leq 120 \text{ MHz}$: 2 m
K_{bw}	Meas Time 5: 1 Meas Time 4: 1 Meas Time 3: 3 at $\leq 1 \text{ MHz}$, 4 at $> 1 \text{ MHz}$ Meas Time 2: 4 at $\leq 1 \text{ MHz}$, 5 at $> 1 \text{ MHz}$ Meas Time 1: 6 at $\leq 1 \text{ MHz}$, 10 at $> 1 \text{ MHz}$
Kz_{osc}	$V_{osc} > 500 \text{ mV}$: 2 $200 \text{ mV} < V_{osc} \leq 500 \text{ mV}$: 1 $100 \text{ mV} < V_{osc} \leq 200 \text{ mV}$: $200/V_{mv}$ $V_{osc} \leq 100 \text{ mV}$: $100/V_{mv}$
Z_s [Ω]	$20 \text{ Hz} \leq f_m < 100 \text{ Hz}$: 10 m $100 \text{ Hz} \leq f_m \leq 120 \text{ MHz}$: 2.5 m

NOTE

f_m : measurement frequency

f : frequency [MHz]

V_{osc} : oscillator level

V_{mv} : V_{osc} [mV]

Impedance measurement accuracy at four-terminal pair port (continued)

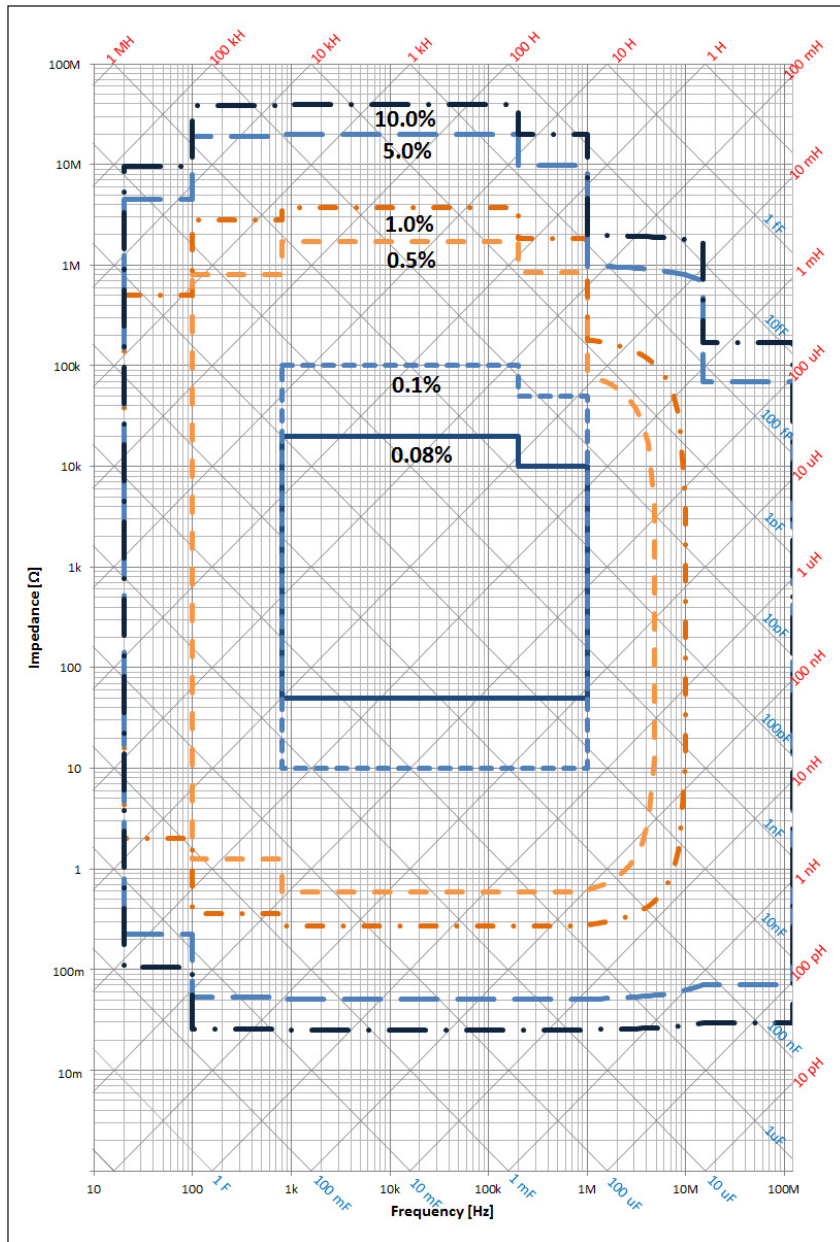

Figure 5. Impedance measurement accuracy at four-terminal pair port of the E4990A's front panel (Oscillator level = 0.5 Vrms, measurement time = 5 (Typical at > 10 MHz))

Impedance measurement accuracy at 7-mm port of the Keysight 42942A

Equation 2 shows the impedance measurement accuracy [%] at 7-mm port of the 42942A terminal adapter.

Equation 2. Impedance Measurement Accuracy [%] at 7-mm port of E4990A

$$E = E_p' + \left(\frac{Z_s'}{|Z_x|} + Y_o' \times |Z_x| \right) \times 100$$

Where,

$$E_p' = E_{pl} + E_{pbw} + E_{posc} + E_p \text{ [%]}$$

$$Y_o' = Y_{ol} + K_{bw} \times Ky_{osc} \times (Y_{odc} + Y_o) \text{ [S]}$$

$$Z_s' = Z_{sl} + K_{bw} \times Kz_{osc} \times Z_s \text{ [\Omega]}$$

E_{pl} [%]	0
E_{pbw} [%]	Meas Time 5: 0 Meas Time 4: 0.06 at < 50 kHz, 0.03 at \geq 50 kHz Meas Time 3: 0.2 at < 50 kHz, 0.1 at \geq 50 kHz Meas Time 2: 0.4 at < 50 kHz, 0.2 at \geq 50 kHz Meas Time 1: 0.8 at < 50 kHz, 0.4 at \geq 50 kHz
E_{posc} [%]	$V_{osc} > 500 \text{ mV}$: $f/100 \times (V_{mv}/500-1)$ $100 \text{ mV} < V_{osc} \leq 500 \text{ mV}$: 0 $V_{osc} \leq 100 \text{ mV}$: $(100/V_{mv}-1) \times (0.05 + E_{pbw})$
E_p [%]	$20 \text{ Hz} \leq f_m \leq 15 \text{ MHz}$: 0.6 $15 \text{ MHz} < f_m \leq 120 \text{ MHz}$: 0.95
Y_{ol} [S]	0
K_{bw}	Meas Time 5: 1 Meas Time 4: 1 Meas Time 3: 3 Meas Time 2: 4 Meas Time 1: 6
Ky_{osc}	$V_{osc} \geq 500 \text{ mV}$: 1 $V_{osc} < 500 \text{ mV}$: $500/V_{mv}$
Y_{odc} [S]	DCI range 1 mA: 0 DCI range 10 mA: 1μ DCI range 100 mA: 10μ

Impedance measurement accuracy at 7-mm port of the Keysight 42942A (continued)

Y_o [S]	$20 \text{ Hz} \leq f_m < 100 \text{ Hz}$: 100 n $100 \text{ Hz} \leq f_m \leq 200 \text{ kHz}$: 25 n^1 $200 \text{ kHz} < f_m \leq 1 \text{ MHz}$: 50 n^1 $1 \text{ MHz} < f_m \leq 120 \text{ MHz}$: $5 \mu\text{f}/100 + 50 \text{ n}^1$
Z_{sl} [Ω]	0
K_{bw}	Meas Time 5: 1 Meas Time 4: 1 Meas Time 3: 3 Meas Time 2: 4 Meas Time 1: 6
Kz_{osc}	$V_{osc} > 500 \text{ mV}$: $2 + f/100$ $200 \text{ mV} < V_{osc} \leq 500 \text{ mV}$: 1 $100 \text{ mV} < V_{osc} \leq 200 \text{ mV}$: $200/V_{mv}$ $V_{osc} \leq 100 \text{ mV}$: $100/V_{mv}$
Z_s [Ω]	$20 \text{ Hz} \leq f_m < 100 \text{ Hz}$: 20 m $100 \text{ Hz} \leq f_m \leq 120 \text{ MHz}$: $5 \text{ m} + 50 \text{ m} \times f/100$

- The specification might not be met at the following range due to internal spurious response.
 - $\pm 10\%$ range of the following frequencies.
 110 kHz, 170 kHz, 220 kHz, 340 kHz, 510 kHz, 600 kHz, 680 kHz, 850 kHz, 1200 kHz.
 - $\pm 2\%$ range of the following frequencies.
 109 kHz \times N (N = 12 to 89)
 118 kHz \times M (M = 11 to 83)

Impedance measurement accuracy at 7-mm port of the Keysight 42942A (continued)

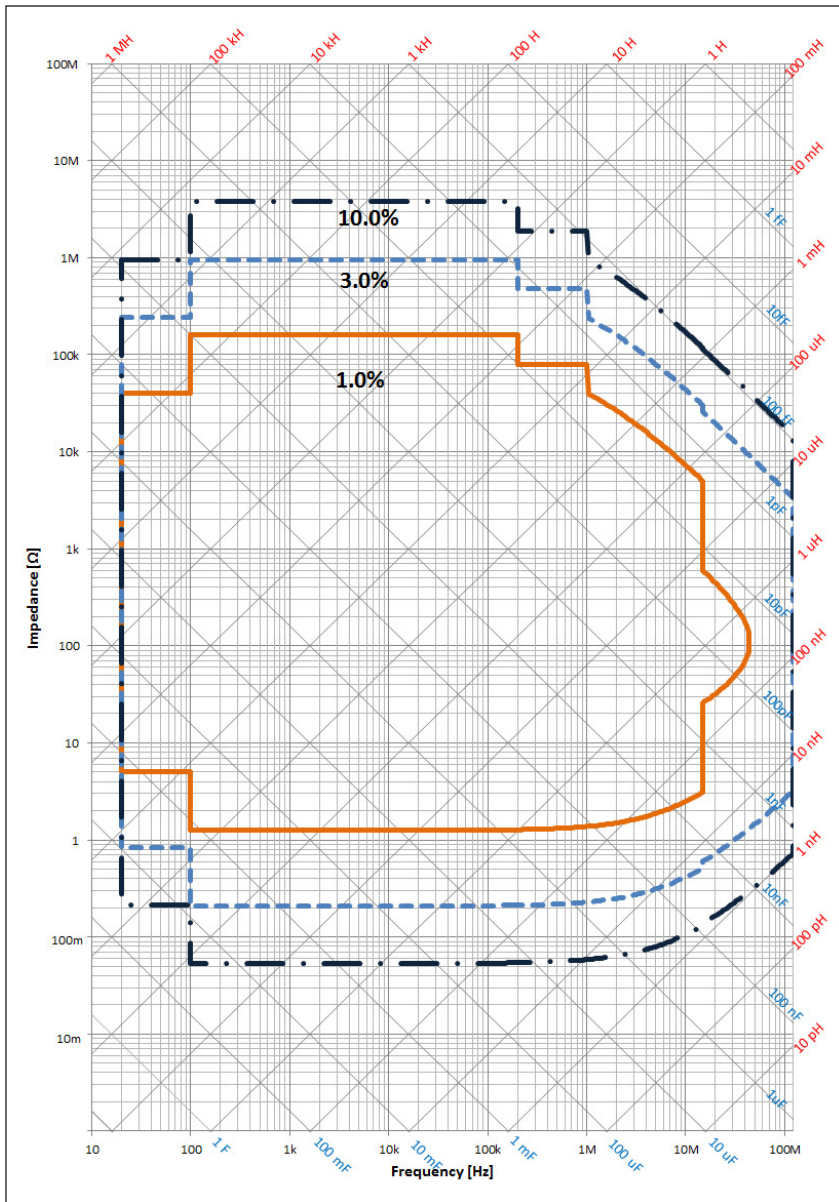

Figure 6. Impedance measurement accuracy at 7-mm port of the Keysight 42942A terminal adapter connected to the E4990A (Oscillator level = 0.5 Vrms), measurement time = 5

Impedance measurement accuracy at test port of the Keysight 42941A

Equation 3 shows the impedance measurement accuracy [%] at test port of the 42941A impedance probe.

Equation 3. Impedance measurement accuracy [%] at test port of the Keysight 42941A

$$E = E_p' + \left(\frac{Z_s'}{|Z_x|} + Y_o' \times |Z_x| \right) \times 100$$

Where,

$$E_p' = E_{pl} + E_{pbw} + E_{posc} + E_p \text{ [%]}$$

$$Y_o' = Y_{ol} + K_{bw} \times Ky_{osc} \times (Y_{odc} + Y_o) \text{ [S]}$$

$$Z_s' = Z_{sl} + K_{bw} \times Kz_{osc} \times Z_s \text{ [\Omega]}$$

E_{pl} [%]	0
E_{pbw} [%]	Meas Time 5: 0 Meas Time 4: 0.06 at < 50 kHz, 0.03 at \geq 50 kHz Meas Time 3: 0.2 at < 50 kHz, 0.1 at \geq 50 kHz Meas Time 2: 0.4 at < 50 kHz, 0.2 at \geq 50 kHz Meas Time 1: 0.8 at < 50 kHz, 0.4 at \geq 50 kHz
E_{posc} [%]	$V_{osc} > 500 \text{ mV}$: $f/100^1 (V_{mv}/500-1)$ $100 \text{ mV} < V_{osc} \leq 500 \text{ mV}$: 0 $V_{osc} \leq 100 \text{ mV}$: $(100/V_{mv}-1) \times (0.05 + E_{pbw})$
E_p [%]	20 Hz $\leq f_m \leq$ 15 MHz: 0.8 15 MHz $< f_m \leq$ 120 MHz: 1.5
Y_{ol} [S]	0
K_{bw}	Meas Time 5: 1 Meas Time 4: 1 Meas Time 3: 3 Meas Time 2: 4 Meas Time 1: 6
Ky_{osc}	$V_{osc} \geq 500 \text{ mV}$: 1 $V_{osc} < 500 \text{ mV}$: $500/V_{mv}$
Y_{odc} [S]	DCI range 1 mA: 0 DCI range 10 mA: 1 μ DCI range 100 mA: 10 μ

Impedance measurement accuracy at test port of the Keysight 42941A (continued)

Y_o [S]	$20 \text{ Hz} \leq f_m < 100 \text{ Hz}$: 100 n $100 \text{ Hz} \leq f_m \leq 200 \text{ kHz}$: 25 n ¹ $200 \text{ kHz} < f_m \leq 1 \text{ MHz}$: 50 n ¹ $1 \text{ MHz} < f_m \leq 120 \text{ MHz}$: 20 μ × f/100 ¹
Z_{sl} [Ω]	0
K_{bw}	Meas Time 5: 1 Meas Time 4: 1 Meas Time 3: 3 Meas Time 2: 4 Meas Time 1: 6
Kz_{osc}	$V_{osc} > 500 \text{ mV}$: 2 + f/100 $200 \text{ mV} < V_{osc} \leq 500 \text{ mV}$: 1 $100 \text{ mV} < V_{osc} \leq 200 \text{ mV}$: 200/ V_{mv} $V_{osc} \leq 100 \text{ mV}$: 100/ V_{mv}
Z_s [Ω]	$20 \text{ Hz} \leq f_m < 100 \text{ Hz}$: 20 m $100 \text{ Hz} \leq f_m \leq 120 \text{ MHz}$: 5 m + 100 m × f/100

1. The specification might not be met at the following range due to internal spurious response.
- ± 10% range of the following frequencies.
110 kHz, 170 kHz, 220 kHz, 340 kHz, 510 kHz, 600 kHz, 680 kHz, 850 kHz, 1200 kHz.
 - ± 2% range of the following frequencies.
109 kHz × N (N = 12 to 89)
118 kHz × M (M = 11 to 83)

Temperature coefficient of the Keysight 42941A impedance probe (typical)

Proportional part (at 50 Ω measurement)	
$ Z $ deviation [ppm/°C]	
at frequency $\leq 1 \text{ MHz}$	< 5
at frequency > 1 MHz	$20 + 500 \times \frac{f}{100}$
θ deviation [μ rad/°C]	
at frequency $\leq 1 \text{ MHz}$	< 5
at frequency > 1 MHz, $\leq 5 \text{ MHz}$	$30 \times \frac{f}{5}$
at frequency > 5 MHz, $\leq 30 \text{ MHz}$	$50 + 150 \times \frac{f}{30}$
at frequency > 30 MHz	200
Residual part	
Residual impedance	$5 \times \frac{f}{100} [\text{m}\Omega / ^\circ\text{C}]$
Residual admittance	$\frac{f}{100} [\mu\text{S} / ^\circ\text{C}]$

Note

f : frequency in MHz

These characteristics apply when the temperature of the probe (tip to 30 cm) is changed.

For accuracy at probe tip, add the following error factors (typical):

Y_o : + 2 π f × 0.1 μ S

Z_s : + 20 m Ω

Impedance measurement accuracy at test port of the Keysight 42941A (continued)

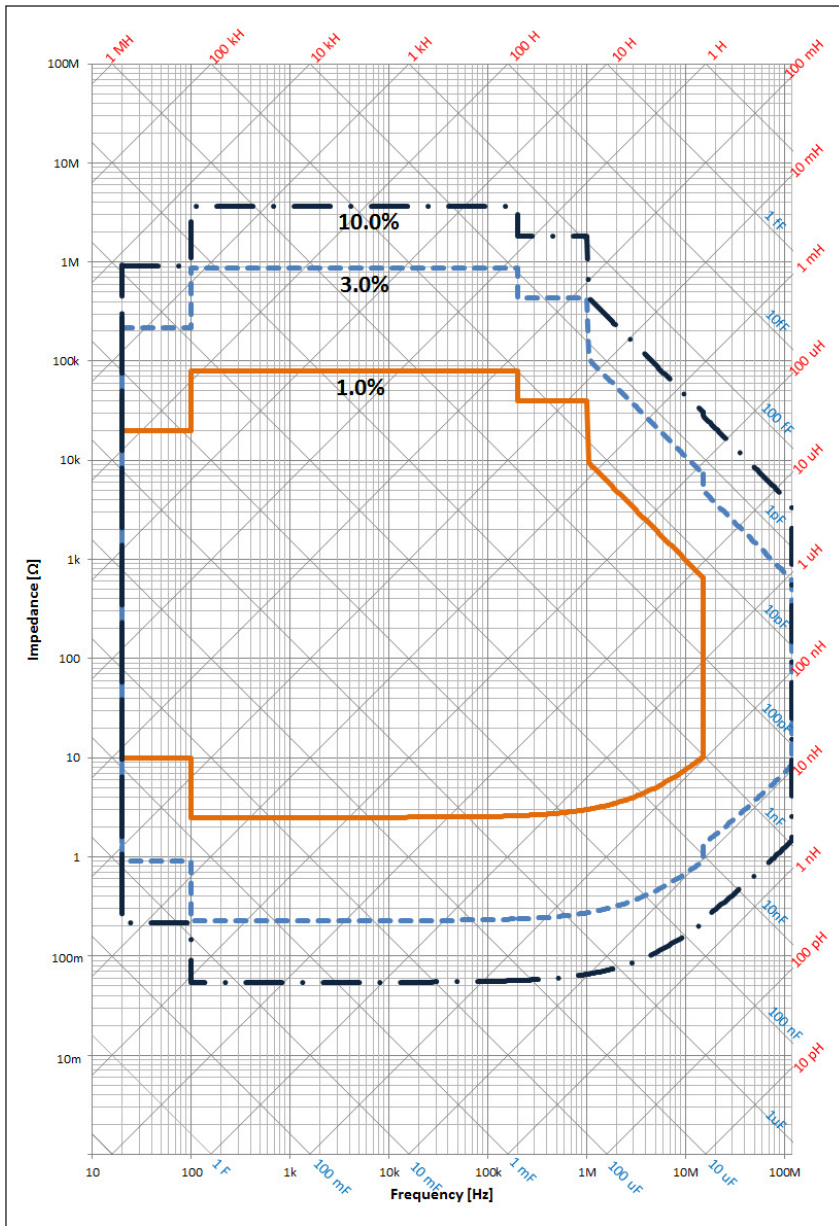

Figure 7. Impedance measurement accuracy at test port of the Keysight 42941A impedance probe connected to the E4990A (Oscillator level = 0.5 Vrms), measurement time = 5

Display Function

Display	
Size/type	10.4 inch color LCD (TFT)
Number of pixels ¹	1024 X 768 (XGA)
Scale type	
X axis scale	Linear and log
Y axis scale	Linear and log (depends on the sweep type)
Number of traces	
Data trace	4 traces per channel
Memory trace	4 traces per channel
Data math function	Data + memory, data - memory, data × memory, data/memory, offset, equation editor

1. Valid pixels are 99.99% and more. Below 0.01% of fixed points of black, blue, green or red are not regarded as failure.

Marker function

Marker type and number	10 independent markers per trace. Reference marker available for delta marker operation.
Marker search	
Search type	Maximum value, minimum value, multi-peak, multi-target, peak, peak left, peak right, target, target left, target right, and width parameters with user defined bandwidth values.
Search track	Performs search by each sweep
Search range	User define
Marker X-axis display	Sweep parameter value, sweep elapsed time, or relaxation time ($1/(2\pi f)$)
Others	Marker continuous mode, Δ marker mode, marker coupled mode, Marker value substitution (Marker→), marker zooming, marker table, marker statistics

Equivalent circuit analysis

Circuit model	3-component model (4 models), 4-component model (3 models)
Analysis type	Equivalent circuit parameters calculation, frequency characteristics simulation

Limit Line Test

Funcions	Define the test limit lines that appear on the display for pass/fail testing. Defined limits may be any combination of horizontal/sloping lines and discrete data points.
Other functions	Beep fail, Limit line offset

Interface

GPIB	24-pin D-Sub (Type D-24), female; compatible with IEEE-488. IEEE-488 interface specification is designed to be used in environment where electrical noise is relatively low. LAN or USBTMC interface is recommended to use at the higher electrical noise environment.
USB host port	Universal serial bus jack, Type A configuration; female; provides connection to mouse, key board, printer or USB stick memory.
USB (USBTMC) interface port	Universal serial bus jack, Type B configuration (4 contacts inline); female; provides connection to an external PC; compatible with USBTMC-USB488 and USB 2.0.LA USB Test and Measurement Class (TMC) interface that communicates over USB, complying with the IEEE 488.1 and IEEE 488.2 standards.
LAN	10/100/1000 Base T Ethernet, 8-pin configuration; auto selects between the two data rates
Video output	15-pin mini D-Sub; female; drives VGA compatible monitors

Handler interface

Connector type	36-pin centronics, female
Signal type	Negative logic, opto-isolated, open collector output
Pin location	See the following figure. Refer to Help for the definition of each pin.

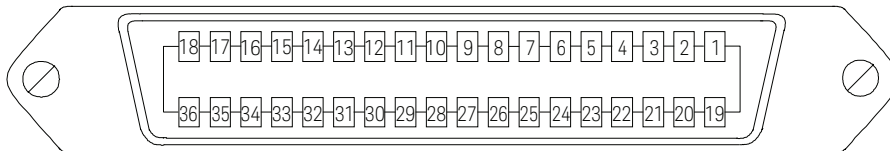

Figure 8. 24 bit I/O port pin assignment

Table 1. 24 bit I/O port pin assignment

Pin No.	Signal Name	Signal Standard
1	GND	0 V
2	INPUT1	TTL level, pulse input, pulse width: 1 μ s or above
3	OUTPUT1	TTL level, latch output
4	OUTPUT2	TTL level, latch output
5	Output port A0	TTL level, latch output
6	Output port A1	TTL level, latch output
7	Output port A2	TTL level, latch output
8	Output port A3	TTL level, latch output
9	Output port A4	TTL level, latch output
10	Output port A5	TTL level, latch output
11	Output port A6	TTL level, latch output
12	Output port A7	TTL level, latch output
13	Output port B0	TTL level, latch output
14	Output port B1	TTL level, latch output
15	Output port B2	TTL level, latch output
16	Output port B3	TTL level, latch output
17	Output port B4	TTL level, latch output
18	Output port B5	TTL level, latch output
19	Output port B6, index (selectable)	TTL level, latch output
20	Output port B7, ready for trigger (selectable)	TTL level, latch output
21	Input/output port C0	TTL level, latch output
22	Input/output port C1	TTL level, latch output
23	Input/output port C2	TTL level, latch output
24	Input/output port C3	TTL level, latch output
25	Input/output port D0	TTL level, latch output
26	Input/output port D1	TTL level, latch output
27	Input/output port D2	TTL level, latch output
28	Input/output port D3	TTL level, latch output
29	Port C status	TTL level, input mode; LOW, output mode: HIGH
30	Port D status	TTL level, input mode; LOW, output mode: HIGH
31	Write strobe signal	TTL level, active low, pulse output (width: 10 μ s, Typical)
32	+5 V pullup	
33	SWEEP END signal	TTL level, active low, pulse output (width: 20 μ s, Typical)
34	+5 V	+5 V, 100 mA MAX
35	PASS/FAIL signal	TTL level, PASS: HIGH, FAIL; LOW, latch output
36	PASS/FAIL write strobe signal	TTL level, active low, pulse output (width: 10 μ s, Typical)

Analyzer Environmental Specifications

Measurement circuit protection

Max discharge withstand voltage ¹	1000 V @ C < 2 μF, $\sqrt{(2/C)}$ V @ C ≥ 2 μF
----------------------------------------------	------------------------------------------------

NOTE: Discharge capacitors before connecting them to the UNKNOWN terminal or a test fixture.

Operating environment

Temperature	+5 °C to +40 °C
Humidity	20% to 80% at wet bulb temperature < +29 °C (non-condensation)
Altitude	0 to 2,000 m (0 to 6561 feet)
Vibration	0.21 Grms maximum, 5 Hz to 500 Hz

Non-operating environment

Temperature	-10 °C to +60 °C
Humidity	20% to 90% at wet bulb temperature < +40 °C (non-condensation)
Altitude	0 to 4,572 m (0 to 15,000 feet)
Vibration	2.09 Grms maximum, 5 to 500 Hz

1. The maximum discharge withstand voltage, where the internal circuit remains protected if a charged capacitor is connected to the UNKNOWN terminal.

General Characteristics

External reference input

Frequency	10 MHz \pm 10 ppm (Typical)
Level	0 dBm to \pm 3 dB (Typical)
Input impedance	50 Ω (nominal)
Connector type	BNC (female)

Internal reference output

Frequency	10 MHz \pm 7 ppm (Typical)
Level	0 dBm \pm 3 dB into 50 Ω (Typical)
Output impedance	50 Ω (nominal)
Connector type	BNC (female)

High stability frequency reference output (Option 1E5)

Frequency	10 MHz \pm 1 ppm
Level	0 dBm minimum
Output impedance	50 Ω (nominal)
Connector type	BNC (female)

External trigger input

Level	TTL
Pulse width (T_p)	$\geq 2 \mu\text{s}$ (Typical); see Figure 9 for the definition of T_p .
Polarity	Positive or negative (selective)
Connector type	BNC (female)

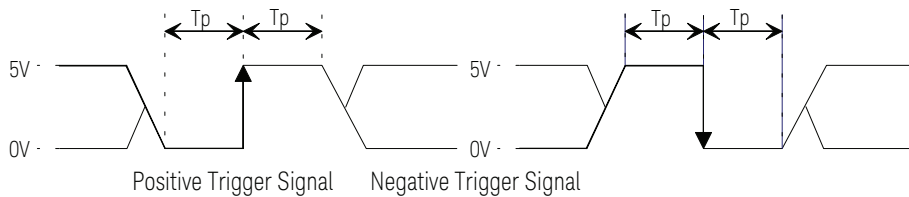





Figure 9. Required pulse width (T_p) for external trigger input

Line power

Frequency	47 to 63 Hz
Voltage	90-264 VAC ($V_{\text{peak}} > 120 \text{ V}$)
VA max	300 VA max.
Power consumption	160 W ¹ (Typical)

1. At preset condition. No application running other than the E4990A on windows.

EMC, safety, environment and compliance

Description	Specification
EMC	
	<p>European Council Directive 2004/108/EC IEC 61326-1:2012 EN 61326-1:2013 CISPR 11:2009 +A1:2010 EN 55011: 2009 +A1:2010 Group 1, Class A IEC 61000-4-2:2008 EN 61000-4-2:2009 4 kV CD / 8 kV AD IEC 61000-4-3:2006 +A1:2007 +A2:2010 EN 61000-4-3:2006 +A1:2008 +A2:2010 3 V/m, 80-1000 MHz, 1.4 - 2.0 GHz / 1V/m, 2.0 - 2.7 GHz, 80% AM IEC 61000-4-4:2004 +A1:2010 EN 61000-4-4:2004 +A1:2010 1 kV power lines / 0.5 kV signal lines IEC 61000-4-5:2005 EN 61000-4-5:2006 0.5 kV line-line / 1 kV line-ground IEC 61000-4-6:2008 EN 61000-4-6:2009 3 V, 0.15-80 MHz, 80% AM IEC 61000-4-8:2009 EN 61000-4-8:2010 30A/m, 50/60Hz IEC 61000-4-11:2004 EN 61000-4-11:2004 0.5-300 cycle, 0% / 70%</p> <p>NOTE-1: When tested at 3 V/m according to EN61000-4-3, the measurement accuracy will be within specifications over the full immunity test frequency range except when the analyzer frequency is identical to the transmitted interference signal test frequency.</p> <p>NOTE-2: When tested at 3 V according to EN61000-4-6, the measurement accuracy will be within specifications over the full immunity test frequency range except when the analyzer frequency is identical to the transmitted interference signal test frequency.</p>
ICES/NMB-001	ICES-001:2006 Group 1, Class A
	AS/NZS CISPR11:2004 Group 1, Class A
	KN11, KN61000-6-1 and KN61000-6-2 Group 1, Class A

Safety



European Council Directive 2006/95/EC
IEC 61010-1:2010 / EN 61010-1:2010
Measurement Category I
Pollution Degree 2
Indoor Use



CAN/CSA C22.2 No. 61010-1-12
Measurement Category I
Pollution Degree 2
Indoor Use

Environment



This product complies with the WEEE Directive (2002/96/EC) marking requirements. The affixed label indicates that you must not discard this electrical/electronic product in domestic household waste.

Product Category: With reference to the equipment types in the WEEE Directive Annex I, this product is classed as a "Monitoring and Control instrumentation" product.
Do not dispose in domestic household waste.

To return unwanted products, contact your local Keysight office, or see <http://www.keysight.com/environment/product/> for more information.

Compliance



Class C

Dimensions, weight

Weight	14 kg
Dimensions	See Figures 10 through 12

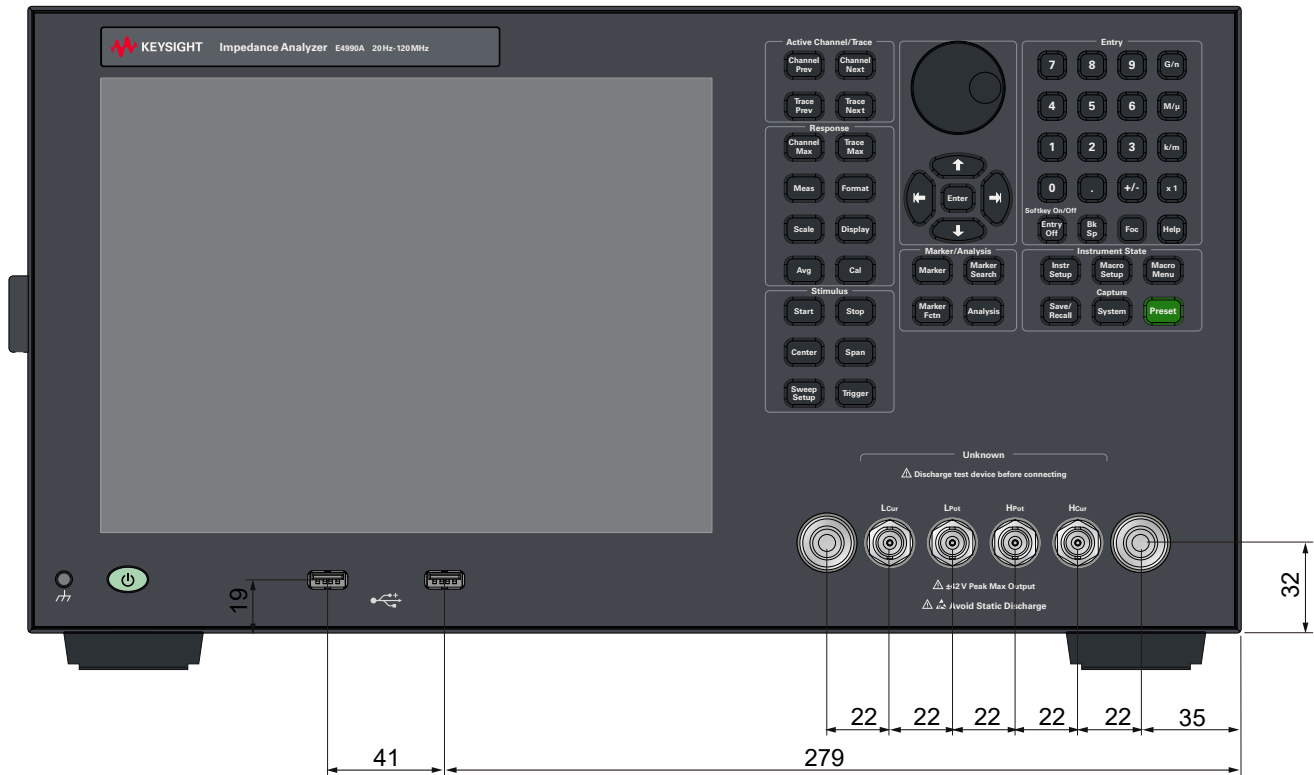

Figure 10. Front view (Millimeters)

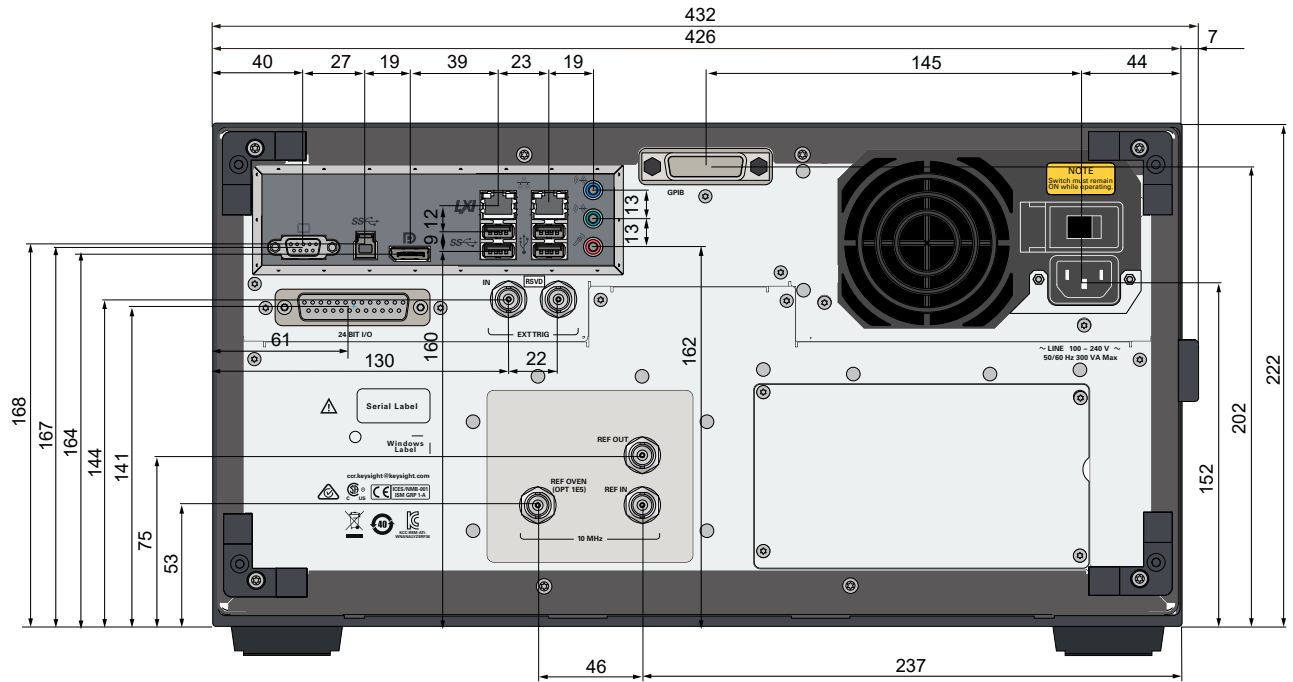

Figure 11. Rear view (Millimeters)

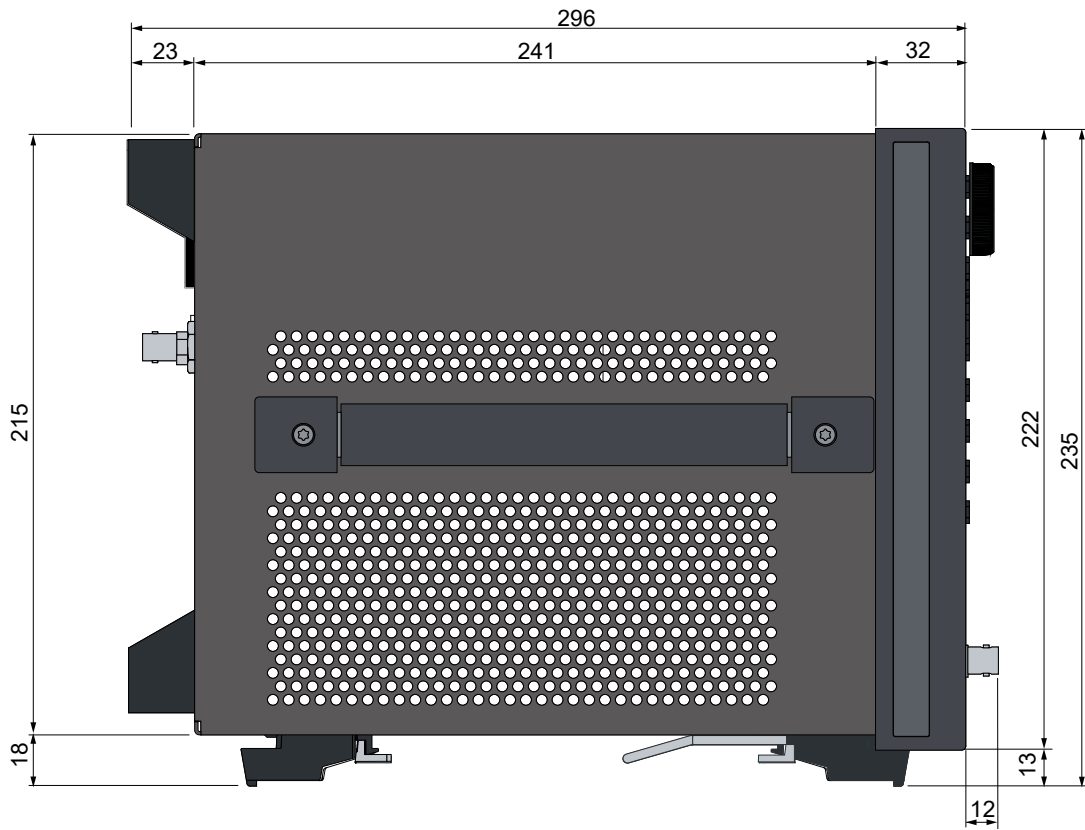

Figure 12. Side view (Millimeters)

Additional Information

Websites

Have access to the following website to acquire the latest news, product and support information, application literature and more.

www.keysight.com/find/impedance

www.keysight.com/find/e4990a

Literature

E4990A, Brochure, 5991-3888EN

E4990A, Configuration Guide, 5991-3891EN

LCR Meters, Impedance Analyzers and Test Fixtures, Selection Guide, 5952-1430E

Accessories Catalog for Impedance Measurements, 5965-4792E

Impedance Measurement Handbook, 5950-3000

Power of Impedance Analyzer - Comparison to Network Analyzer, 5992-0338EN

Learn more at: www.keysight.com

For more information on Keysight Technologies' products, applications or services, please contact your local Keysight office. The complete list is available at:

www.keysight.com/find/contactus

