

# EXG X-Series Signal Generators N5171B Analog & N5172B Vector

9 kHz to 1, 3, or 6 GHz

9 kHz to 7.2 GHz<sup>1</sup>



1. Only applicable to N5172B + N5182BX07 Frequency Extender

# Table of Contents

|   |    |
|---|----|
| Definitions and conditions.....                     | 2  |
| Frequency specifications.....                       | 3  |
| Amplitude specifications.....                       | 5  |
| Spectral purity specifications.....                 | 10 |
| Analog modulation specifications.....               | 12 |
| Vector modulation specifications - N5172B only..... | 17 |
| General specifications.....                         | 28 |
| Inputs and outputs.....                             | 29 |
| Related literature.....                             | 31 |

## Optimized for manufacturing

On the path to faster throughput and greater uptime, the cost-effective EXG X-Series signal generators are optimized for manufacturing test. With analog and vector models, the EXG provides the signals you'll need for basic parametric testing of components and functional verification of receivers. Get "just enough" test at the right price with the EXG.

## Definitions and Conditions

Specifications represent warranted performance of a calibrated instrument that has been stored for a minimum of 2 hours within the operating temperature range of 0 to 55 °C, unless otherwise stated, and after a 45 minute warm-up period. The specifications include measurement uncertainty. Data represented in this document are specifications unless otherwise noted.

Typical (typ) describes additional product performance information. It is performance beyond specifications that 80 percent of the units exhibit with a 90 percent confidence level at room temperature (approximately 25 °C). Typical performance does not include measurement uncertainty.

Nominal (nom) values indicate the expect mean or average performance, or an attribute whose performance is by design, such as the 50 ohm connector. This data is not warranted and is measured at room temperature (approximately 25 °C).

Measured (meas) describes an attribute measured during the design phase for purposes of communicating expected performance, such as amplitude drift vs. time. This data is not warranted and is measured at room temperature (approximately 25 °C).

## Frequency Specifications

| Frequency range                          |  |   |                     |
|--|--|---|---------------------|
| Frequency range                          | Option 501 (N5171B only)               | 9 kHz to 1 GHz                                |                     |
|  | Option 503                             | 9 kHz (5 MHz IQ mode) to 3 GHz                |                     |
|  | Option 506                             | 9 kHz (5 MHz IQ mode) to 6 GHz                |                     |
|  | Option 506 + FRQ                       | 9kHz (5 MHz I/Q mode) to 7.2 GHz <sup>1</sup> |                     |
| Resolution                               | 0.001 Hz                               |   |                     |
| Phase offset                             | Adjustable in nominal 0.1 ° increments |   |                     |
| Frequency bands <sup>2</sup>             |  |   |                     |
|  | Band                                   | Frequency range                               | N                   |
|  | 1                                      | 9 kHz to < 5 MHz                              | Digital synthesis   |
|  | 1                                      | 5 to < 250 MHz                                | 1                   |
|  | 2                                      | 250 to < 375 MHz                              | 0.25                |
|  | 3                                      | 375 to < 750 MHz                              | 0.5                 |
|  | 4                                      | 750 to < 1500 MHz                             | 1                   |
|  | 5                                      | 1500 to < 3000.001 MHz                        | 2                   |
|  | 6                                      | 3000.001 to 6000 MHz                          | 4                   |
| Frequency switching speed <sup>3,4</sup> |  |   |                     |
|  | Standard                               | Option UNZ <sup>5</sup>                       | Option UNZ, typical |
| CW mode                                  |  |   |                     |
| SCPI mode                                | ≤ 5 ms, typical                        | ≤ 1.15 ms                                     | ≤ 950 μs            |
| List/step sweep mode                     | ≤ 5 ms, typical                        | ≤ 900 μs                                      | ≤ 800 μs            |
| Digital modulation on (N5172B only)      |  |   |                     |
| SCPI mode                                | ≤ 5 ms, typical                        | ≤ 1.15 ms                                     | ≤ 1.05 ms           |
| List/step sweep mode                     | ≤ 5 ms, typical                        | ≤ 900 μs                                      | ≤ 800 μs            |

1. Only applicable to N5182B. Requires option 506 and N5182BX07 Frequency Extender
2. N is a factor used to help define certain specifications within the document.
3. Time from receipt of SCPI command or trigger signal to within 0.1 ppm of final frequency or within 100 Hz, whichever is greater, and amplitude settled to within 0.2 dB from 20 to 30 °C. When switching into or out of band 6 amplitude settling time is within 0.3 dB. Implies simultaneous frequency and amplitude switching.
4. With internal channel corrections on, the frequency switching speed is < 1.3 ms, measured for list mode and SCPI mode cached frequency points. For the initial frequency point in SCPI mode the time is < 3.3 ms, measured. The instrument will automatically cache the most recently used 1024 frequencies. There is no speed degradation for amplitude-only changes.
5. Specifications apply when status register updates are off. For export control purposes CW switching speed to within 0.05% of final frequency is 190 μs (measured).

| <b>Frequency reference</b>                                      |   |
|---|---|
| Accuracy  | ± (time since last adjustment x aging rate)<br>± temperature effects<br>± line voltage effects<br>± calibration accuracy  |
| Internal time base reference oscillator aging rate <sup>1</sup> | ≤ ± 5 ppm/10 yrs, < ± 1 ppm/yr  |
| Initial achievable calibration accuracy                         | ± 4 x 10 <sup>-8</sup> or ± 40 ppb  |
| Adjustment resolution   | < 1 x 10 <sup>-10</sup>   |
| Temperature effects   | ± 1 ppm (0 to 55 °C), nominal   |
| Line voltage effects  | ± 0.1 ppm, nominal; 5% to -10%, nominal   |
| <b>Reference output</b>   |   |
| Frequency   | 10 MHz  |
| Amplitude   | ≥ +4 dBm, nominal into 50 Ω load  |
| <b>External reference input</b>                                 |   |
| Input frequency, standard                                       | 10 MHz  |
| Input frequency, Option 1ER                                     | 1 to 50 MHz (in multiples of 0.1 Hz)  |
| Stability   | Follows the stability of external reference input signal  |
| Lock range  | ± 1 ppm   |
| Amplitude   | > -3.0 to 20 dBm, nominal   |
| Impedance   | 50 Ω, nominal   |
| Waveform  | Sine or square  |
| <b>Sweep modes (frequency and amplitude)</b>                    |   |
| Operating modes   | Step sweep (equally spaced frequency and amplitude or logarithmically spaced frequency steps)<br>List sweep (arbitrary list of frequency and amplitude steps)<br>Simultaneously sweep waveforms with N5172B; see Baseband Generator section for more detail |
| Sweep range   | Within instrument frequency range   |
| Dwell time  | 100 μs to 100 s   |
| Number of points  | 2 to 65535 (step sweep)<br>1 to 3201 (list sweep)   |
| Step change   | Linear or logarithmic   |
| Triggering  | Free run, trigger key, external, timer, bus (GPIB, LAN, USB)  |

1. Not verified by Keysight N7800A TME Calibration and Adjustments Software. Daily aging rate may be verified as a supplementary chargeable service, on request.

# Amplitude Specifications

| Output parameters                          |  |                   |
|--|--|-------------------|
| Settable range                             | +19 to -144 dBm (Standard)<br>+30 to -144 dBm (Option 1EA) |                   |
| Resolution                                 | 0.01 dB  |                   |
| Step attenuator                            | 0 to 130 dB in 5 dB steps electronic type                  |                   |
| Connector                                  | Type N 50 Ω, nominal                                       |                   |
| Max output power <sup>1</sup> () = typical |  |                   |
| Frequency                                  | Standard   | Option 1EA        |
| 9 kHz to 10 MHz                            | +13 dBm  | +17 dBm (+18 dBm) |
| > 10 MHz to 3 GHz                          | +18 dBm  | +21 dBm (+26 dBm) |
| > 3 to 6 GHz                               | +16 dBm  | +18 dBm (+19 dBm) |

1. Quoted specifications between 20 °C and 30 °C. Maximum output power typically decreases by 0.01 dB/°C for temperatures outside this range.

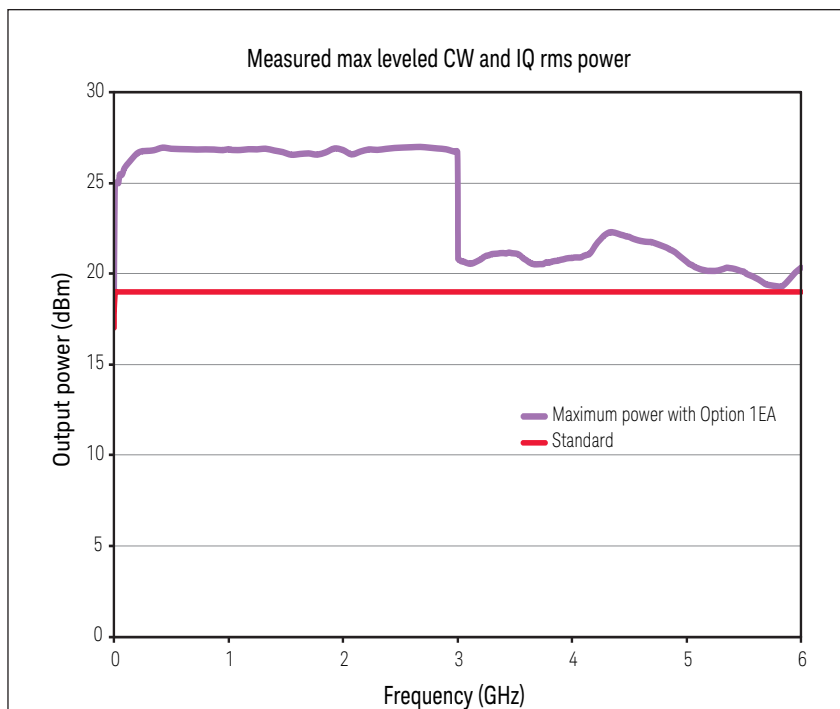

| Absolute level accuracy in CW mode <sup>1</sup> (ALC on) ()= typical               |                      |                   |                    |
|--|----------------------|-------------------|--------------------|
| Range  | Max power to -60 dBm | < -60 to -110 dBm | < -110 to -127 dBm |
| 9 to 100 kHz   | (± 0.6)              | (± 0.9)           |                    |
| 100 kHz to 5 MHz   | ± 0.8 dB (± 0.3)     | ± 0.9 dB (± 0.3)  |                    |
| > 5 MHz to 3 GHz   | ± 0.6 dB (± 0.3)     | ± 0.8 dB (± 0.3)  | (± 0.5)            |
| > 3 to 6 GHz   | ± 0.6 dB (± 0.3)     | ± 1.1 dB (± 0.3)  | (± 0.6)            |
| Absolute level accuracy in CW mode (ALC off, power search run, relative to ALC on) |                      |                   |                    |
| 9 kHz to 6 GHz   | ± 0.15 dB, typical   |                   |                    |
| Absolute level accuracy in digital I/Q mode (N5172B only)                          |                      |                   |                    |
| (ALC on, relative to CW, W-CDMA 1 DPCH configuration < +10 dBm)                    |                      |                   |                    |
| 5 MHz to 6 GHz   | ± 0.25 dB, (0.05 dB) |                   |                    |

1. Quoted specifications between 20 °C and 30 °C. For temperatures outside this range, absolute level accuracy degrades by 0.01 dB/°C. Output power may drift up to 0.10 dB < 3 GHz and 0.15 dB > 3 GHz per g/kg change in absolute humidity (nom).

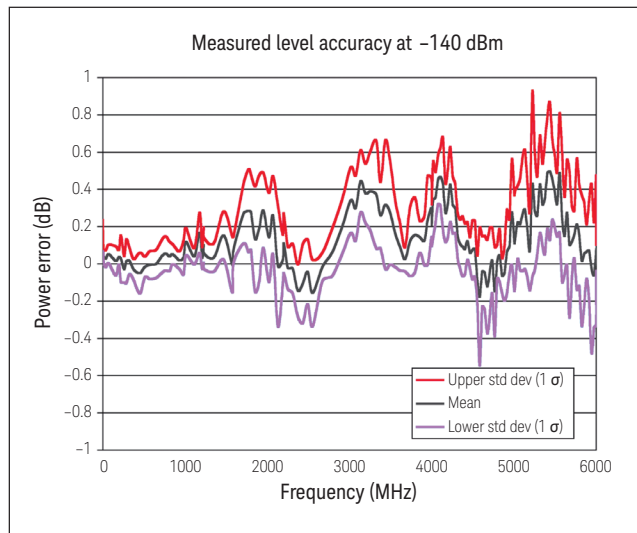
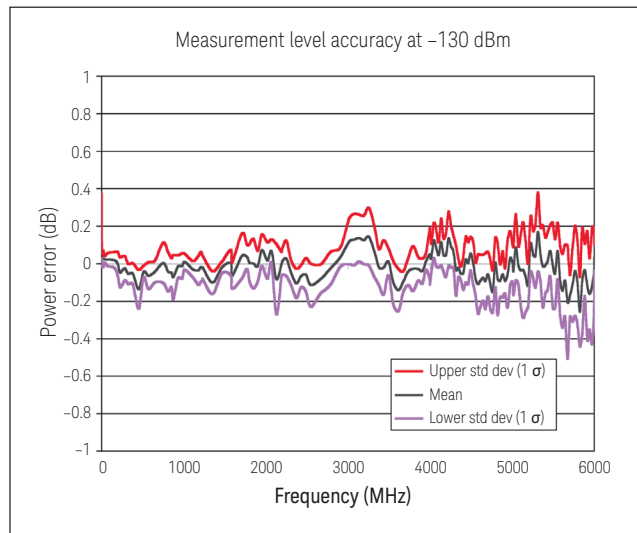
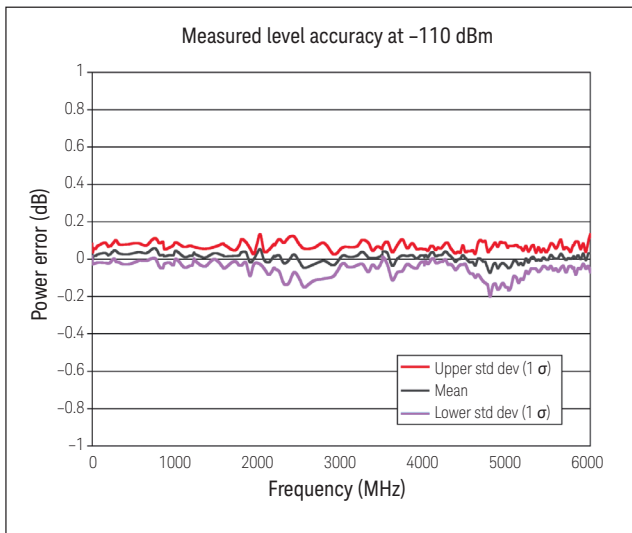

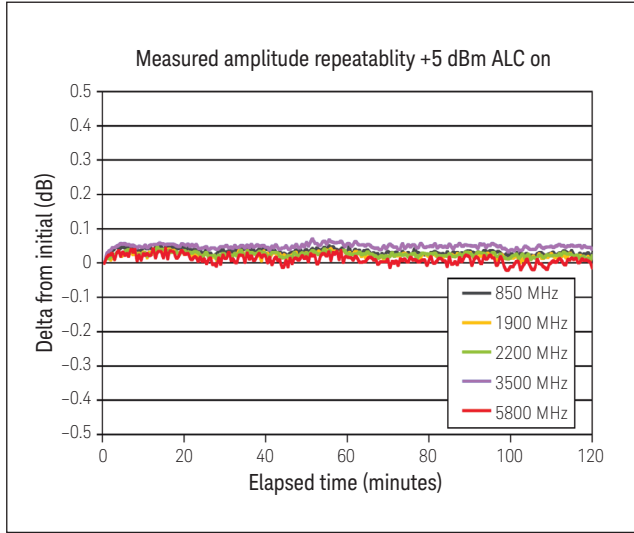

Repeatability measures the ability of the instrument to return to a given power setting after a random excursion to any other frequency and power setting. It should not be confused with absolute level accuracy.

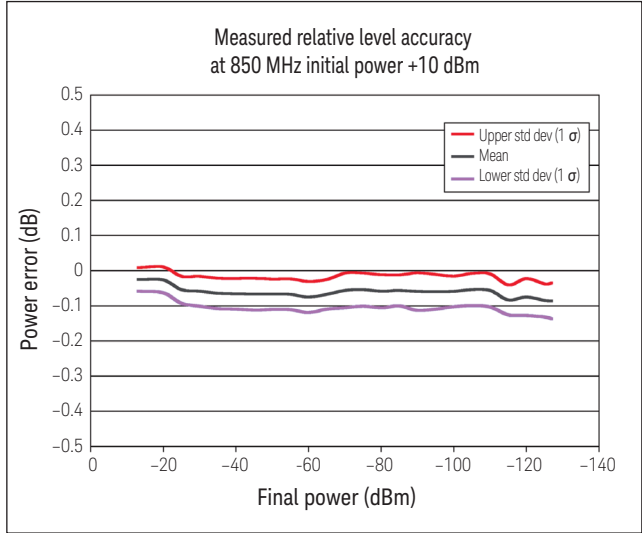

Relative level accuracy measures the accuracy of a step change from any power level to any other power level. This is useful for large changes (such as 5 dB steps).

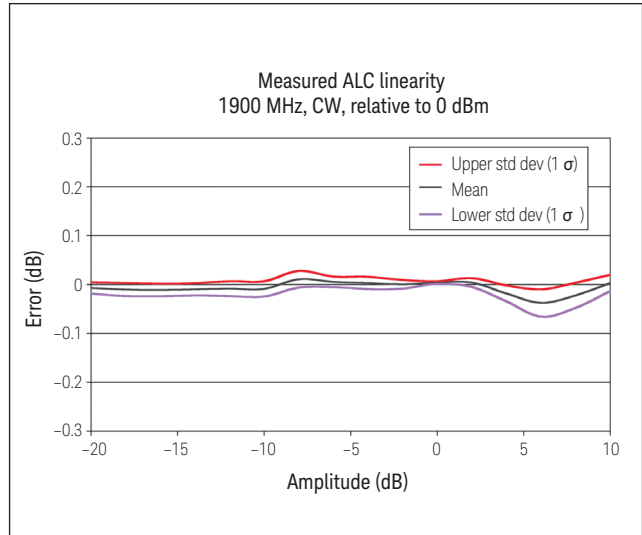
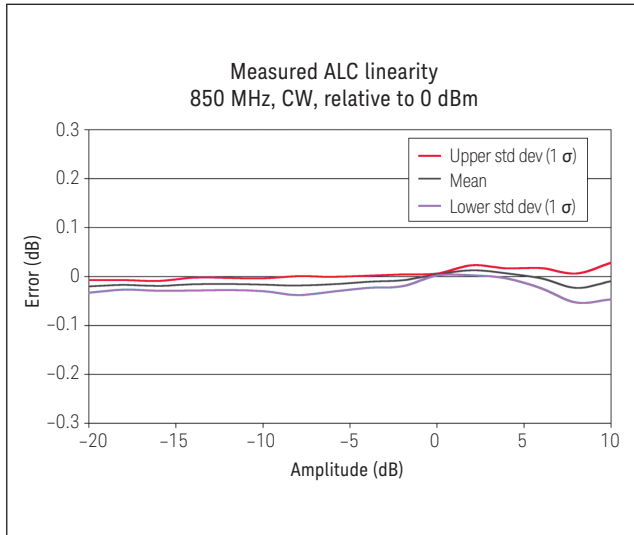

| SWR (measured CW mode) <sup>1</sup> |                  |            |               |
|-------------------------------------|------------------|------------|---------------|
| Frequency                           | Attenuator state |            |               |
|                                     | Bypass           | 0 to 10 dB | 15 dB or more |
| ≤ 1.0 GHz                           | < 1.3:1          | < 1.35:1   | < 1.2:1       |
| > 1.0 to 2 GHz                      | < 1.55:1         | < 1.5:1    | < 1.3:1       |
| > 2 to 3 GHz                        | < 1.8:1          | < 1.5:1    | < 1.45:1      |
| > 3 to 4 GHz                        | < 1.5:1          | < 1.6:1    | < 1.7:1       |
| > 4 to 6 GHz                        | < 1.9:1          | < 1.6:1    | < 1.6:1       |

1. SWR < 1.60:1 below 30 kHz.

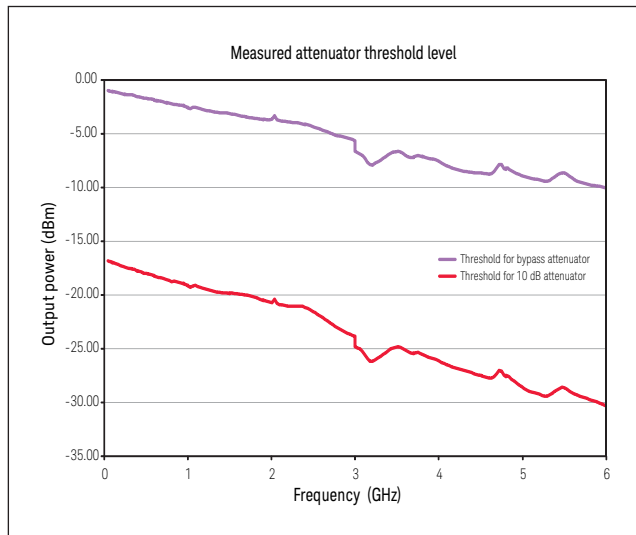
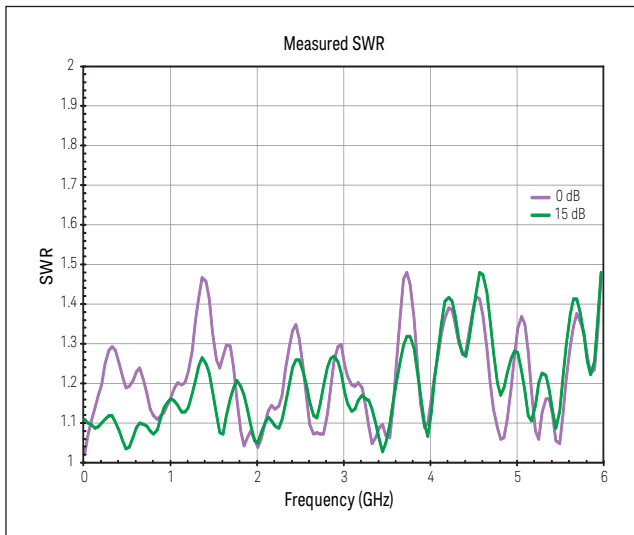



| <b>Maximum reverse power, nominal</b>              |   |                   |                            |
|--|---|-------------------|----------------------------|
| < 1 GHz  | 50 W  |                   |                            |
| > 1 to 2 GHz                                       | 25 W  |                   |                            |
| > 2 to 6 GHz                                       | 20 W  |                   |                            |
| Max DC voltage                                     | 50 VDC  |                   |                            |
| Trip level   | 2 W   |                   |                            |
| <b>Amplitude switching speed<sup>1</sup></b>       | <b>Standard</b>   | <b>Option UNZ</b> | <b>Option UNZ, typical</b> |
| CW mode  |   |                   |                            |
| SCPI mode  | ≤ 5 ms, typical   | ≤ 750 μs          | ≤ 650 μs                   |
| Power search SCPI mode                             | < 12 ms, measured   |                   |                            |
| List/step sweep mode                               | ≤ 5 ms, typical   | ≤ 500 μs          | ≤ 300 μs                   |
| Digital modulation on (N5172B only)                |   |                   |                            |
| SCPI mode  | ≤ 5 ms, typical   | ≤ 1.15 ms         | ≤ 950 μs                   |
| Power search SCPI mode                             | < 12 ms, measured   |                   |                            |
| List/step sweep mode                               | ≤ 5 ms, typical   | ≤ 900 μs          | ≤ 400 μs                   |
| <b>Alternate power level control (N5172B only)</b> |   |                   |                            |
| Switching time<br>(via waveform markers)           | 20 μs within ± 1 dB, measured   |                   |                            |
| Functional power range                             | -15 dBm to -144 dBm, measured   |                   |                            |
| <b>User flatness correction</b>                    |   |                   |                            |
| Number of points                                   | 3201  |                   |                            |
| Number of tables                                   | Dependent on available free memory in instrument; 10,000 maximum  |                   |                            |
| Entry modes  | USB/LAN direct power meter control, LAN to GPIB and USB to GPIB, remote bus and manual USB/GPIB power meter control |                   |                            |
| <b>Sweep modes</b>                                 |   |                   |                            |
|  | See Frequency Specifications section for more detail  |                   |                            |

1. Time from receipt of SCPI command or trigger signal to amplitude settled within 0.2 dB. Switching speed specifications apply when status register updates are off.

# Spectral Purity Specifications

| Absolute SSB phase noise (dBc/Hz, CW at 20 kHz offset, typical) |      |
|---|------|
| 5 MHz to < 250 MHz  | -119 |
| 250 MHz   | -133 |
| 500 MHz   | -128 |
| 1 GHz   | -122 |
| 2 GHz   | -115 |
| 3 GHz   | -110 |
| 4 GHz   | -109 |
| 6 GHz   | -103 |

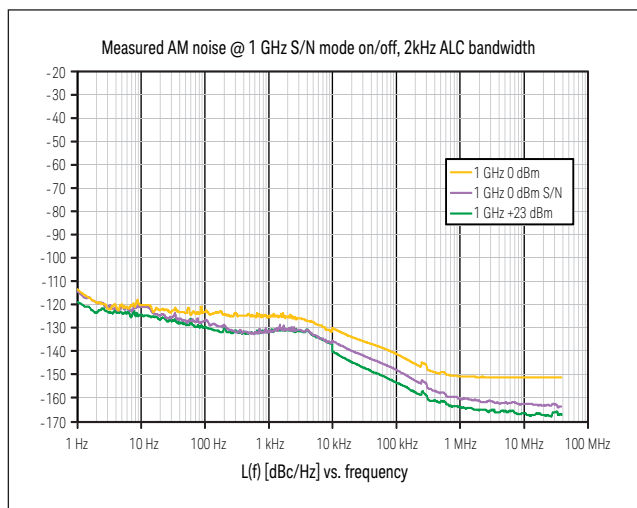
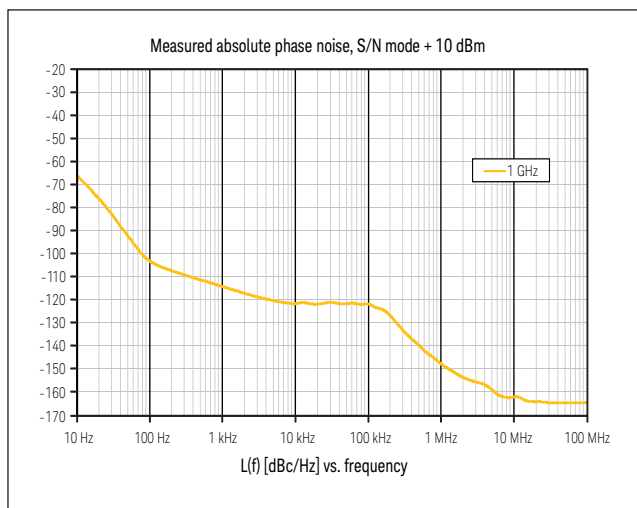
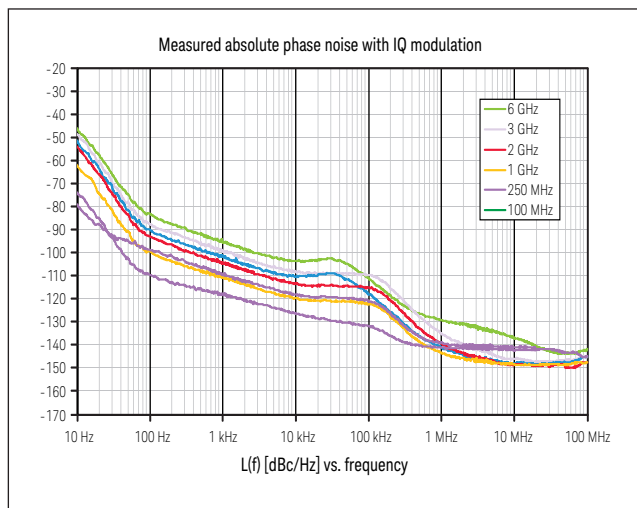
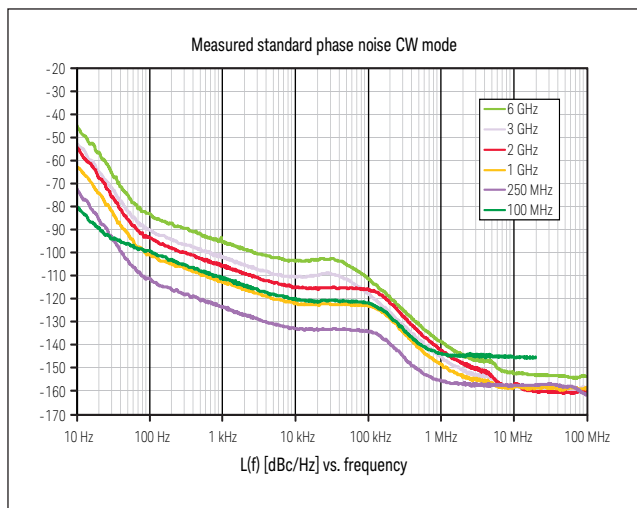

| <b>Residual FM (CW mode, 300 Hz to 3 kHz BW, CCITT, rms)</b> |   |
|--|---|
| 5 MHz to 6 GHz   | < N x 2 Hz (measured) (see N value in frequency band table) |

| <b>Residual AM (CW mode, 0.3 to 3 kHz BW, rms, +5 dBm)</b> |                    |
|--|--------------------|
| 100 kHz to 3 GHz   | < 0.01% (measured) |

| <b>Harmonics (CW mode)</b> |                    |                      |
|----------------------------|--------------------|----------------------|
| Range                      | Standard < +4 dBm  | Option 1EA < +12 dBm |
| 9 kHz to 3 GHz             | < -35 dBc          | < -30 dBc            |
| > 3 to 4 GHz               | < -35 dBc, typical | < -35 dBc, typical   |
| > 4 to 6 GHz               | < -53 dBc, typical | < -40 dBc, typical   |

| <b>Nonharmonics (CW mode)</b> |                 |
|-------------------------------|-----------------|
| Range                         | > 10 KHz offset |
|                               | Standard (dBc)  |
| 9 kHz to < 5 MHz              | -65, nominal    |
| 5 to < 250 MHz                | -75             |
| 250 to < 750 MHz              | -75             |
| 750 MHz to < 1.5 GHz          | -72             |
| 1.5 to < 3.0 GHz              | -66             |
| 3 to 6 GHz                    | -60             |

| <b>Subharmonics (CW mode)</b> |         |
|-------------------------------|---------|
| 9 kHz to 1.5 GHz              | None    |
| > 1.5 to 3 GHz                | -77 dBc |
| > 3 to 6 GHz                  | -74 dBc |

| <b>Jitter <sup>1</sup></b> |                     |                   |                   |                  |
|----------------------------|---------------------|-------------------|-------------------|------------------|
| Carrier frequency          | SONET/SDH data rate | rms jitter BW     | μUI rms, measured | Seconds, typical |
| 155 MHz                    | 155 MB/s            | 100 Hz to 1.5 MHz | 140               | 0.9 ps           |
| 622 MHz                    | 622 MB/s            | 1 KHz to 5 MHz    | 67                | 0.11 ps          |
| 2.488 GHz                  | 2488 MB/s           | 5 kHz to 20 MHz   | 271               | 0.11 ps          |

| <b>Phase coherence (Option 012)</b> |                           |
|-------------------------------------|---------------------------|
| LO input frequency range            | 250 MHz to 6 GHz, nominal |
| LO input power range                | 0 to +12 dBm, nominal     |
| LO output frequency range           | 250 MHz to 6 GHz, nominal |
| LO output power range               | 0 to +12 dBm, nominal     |

1. Calculated from phase noise performance in CW mode at +10 dBm. For other frequencies, data rates, or bandwidths, please consult your sales representative.

## Analog Modulation Specifications

| Frequency bands                                       |  |  |
|---|--|--|
| Band #  | Frequency range  | N  |
| 1   | 9 kHz to < 5 MHz   | 1 (digital synthesis)  |
| 1   | 5 to < 250 MHz   | 1  |
| 2   | 250 to < 375 MHz   | 0.25   |
| 3   | 375 to < 750 MHz   | 0.5  |
| 4   | 750 to < 1500 MHz  | 1  |
| 5   | 1500 to < 3000.001 MHz   | 2  |
| 6   | 3000.001 to 6000 MHz   | 4  |
| Frequency modulation (Option UNT) (See N value above) |  |  |
| Max deviation   | N × 10 MHz, nominal <sup>3</sup>                                 |  |
| Resolution  | 0.025% of deviation or 1 Hz, whichever is greater, nominal       |  |
| Deviation accuracy                                    | < ± 2% + 20 Hz (1 kHz rate, deviation is N × 50 kHz)             |  |
| Modulation frequency response<br>@ 100 KHz rate       | 1 dB bandwidth   | DC/5 Hz to 3 MHz, nominal  |
|   | 3 dB bandwidth   | DC/1 Hz to 7 MHz, nominal  |
| Carrier frequency accuracy                            | < ± 0.2% of set deviation + (N × 1 Hz) <sup>1</sup>              |  |
| Relative to CW in DCFM                                | < ± 0.06% of set deviation + (N × 1 Hz), typical <sup>2</sup>    |  |
| Distortion  | < 0.4% [1 kHz rate, deviation is N × 50 kHz]                     |  |
| FM using external inputs 1 or 2                       | Sensitivity  | +1 V peak for indicated deviation, nominal                             |
|   | Input impedance  | 50 Ω/600 Ω/1 M Ω, nominal  |
|   | Paths  | FM path 1 and FM path 2 are summed internally for composite modulation |
| Phase modulation (Option UNT) (See N value above)     |  |  |
| Maximum deviation                                     | Normal bandwidth   | N × 5 radians, nominal   |
|   | High-bandwidth mode  | N × 0.5 radians, nominal   |
| Frequency response                                    | Normal bandwidth (3 dB)  | DC to 1 MHz, nominal   |
|   | High-bandwidth mode (3 dB)                                       | DC to 4 MHz, nominal   |
| Resolution  | 0.1% of deviation  |  |
| Deviation accuracy                                    | < + 0.5% + 0.01 rad, typical [1 kHz rate, normal bandwidth mode] |  |
| Distortion  | < 0.2% (typ) [1 kHz rate, deviation normal bandwidth mode]       |  |
| ΦM using external inputs 1 or 2                       | Sensitivity  | +1 V peak for indicated deviation, nominal                             |
|   | Input impedance  | 50 Ω or 600 Ω or 1 M Ω, nominal  |
|   | Paths  | ΦM path 1 and ΦM path 2 are summed internally for composite modulation |

1. Specification valid for temperature changes of less than ± 5 °C since last DCFM calibration.

2. Typical performance immediately after a DCFM calibration.

3. Digital synthesis band FM deviation is 5 MHz.

| <b>Amplitude modulation (Option UNT) <sup>1</sup></b>     |   |   |                  |       |                           |                           |
|---|---|---|------------------|-------|---------------------------|---------------------------|
| AM depth type   | Linear or exponential   |   |                  |       |                           |                           |
| Maximum depth   | 100%  |   |                  |       |                           |                           |
| Depth resolution  | 0.1% of depth (nom)   |   |                  |       |                           |                           |
| AM depth error<br>@1 KHz rate and < 80% depth             | f < 5 MHz   | < 1.5% of setting + 1% (typ 0.5% of setting + 1%)                                 |                  |       |                           |                           |
|   | 5 MHz ≤ f ≤ 2 GHz   | < 3% of setting + 1 %   |                  |       |                           |                           |
|   | 2 < f < 3 GHz   | < 5% of setting + 1% (typical 3% of setting + 1%)                                 |                  |       |                           |                           |
|   | 3 < f < 6 GHz   | (typical 4% of setting + 1%)  |                  |       |                           |                           |
| Total harmonic distortion<br>@ 1 KHz rate                 | F < 5 MHz   | 30% depth   | < 0.25%, typical |       |                           |                           |
|   |   | 80% depth   | < 0.5%, typical  |       |                           |                           |
|   | 5 MHz ≤ f < 2 GHz<br>(2 to 3 GHz is typical)  | 30% depth   | < 2%             |       |                           |                           |
|   |   | 80% depth   | < 2%             |       |                           |                           |
| Frequency response  | 30% depth, 3 dB BW  | DC/10 Hz to 50 KHz  |                  |       |                           |                           |
| Frequency response wideband AM<br>(N5172B only)           | Rates ALC off/on:   | DC/800 Hz to 80 MHz, nominal  |                  |       |                           |                           |
| AM inputs using external inputs<br>1 or 2                 | Sensitivity   | ± 1 V peak for indicated depth (Over-range can be 200% or 2.2 V peak)             |                  |       |                           |                           |
|   | Input impedance   | 50 Ω or 600 Ω or 1M Ω, Damage level: ± 5 V max                                    |                  |       |                           |                           |
|   | Paths   | AM path 1 and AM path 2 are summed internally for composite modulation            |                  |       |                           |                           |
| Wideband AM inputs<br>(N5172B only)                       | Sensitivity   | 1 V peak-to-peak sine wave signal with 0.5 V DC offset required input for 100% AM |                  |       |                           |                           |
|   | Input impedance   | 50 Ω, nominal (I input)   |                  |       |                           |                           |
| <b>Simultaneous and composite modulation <sup>2</sup></b> |   |   |                  |       |                           |                           |
| Simultaneous modulation                                   | All modulation types (I/Q, FM, AM, ΦM, and pulse modulation) may be simultaneously enabled except: FM and phase modulation cannot be combined and two modulation types cannot be simultaneously generated using the same modulation source; for example, the baseband I/Q generator, AM, and FM can run concurrently and all will modulate the output RF (this is useful for simulating signal impairments) |   |                  |       |                           |                           |
| Composite modulation                                      | AM, FM, and ΦM each consist of two modulation paths which are summed internally for composite modulation; modulation can be any combination of internal or external sources   |   |                  |       |                           |                           |
|   | AM  | FM  | Phase            | Pulse | Internal I/Q <sup>2</sup> | External I/Q <sup>2</sup> |
| AM  | +   | +   | +                | +     | +                         | +                         |
| FM  | +   | +   | -                | +     | +                         | +                         |
| Phase   | +   | -   | +                | +     | +                         | +                         |
| Pulse   | +   | +   | +                | -     | +                         | +                         |
| Internal I/Q <sup>2</sup>                                 | +   | +   | +                | +     | *                         | +                         |
| External I/Q <sup>2</sup>                                 | +   | +   | +                | +     | +                         | -                         |
| + = compatible, - = incompatible, * = Internal + External |   |   |                  |       |                           |                           |

1. AM specifications apply 6 dB below maximum specified power from 20 to 30 °C.

2. I/Q modulation available on N5172B.

| <b>External modulation inputs</b>   |  |
|---|--|
| <b>(Option UNT required for FM, AM, and phase modulation inputs; Option UNW required for pulse modulation inputs)</b>   |  |
| EXT1  | AM, FM, PM   |
| EXT2  | AM, FM, PM   |
| PULSE   | Pulse (50 Ω only)  |
| I   | Wideband AM (50 Ω only, N5172B only)   |
| Input impedance   | 50 Ω, 1 MΩ, 600 Ω, DC and AC coupled   |
| <b>Standard internal analog modulation source</b>   |  |
| <b>(Single sine wave generator for use with AM, FM, phase modulation requires Option UNT or 303)</b>  |  |
| Waveform  | Sine, square, triangle, positive ramp, negative ramp   |
| Rate range  | 0.1 Hz to 2 MHz (tunable to 3 MHz)   |
| Resolution  | 0.1 Hz   |
| Frequency accuracy  | Same as RF reference source, nominal   |
| LF audio output   | 0 to 5 V peak into 50 Ω, -5 V to 5 V offset, nominal   |
| <b>Multifunction generator (Option 303)</b>   |  |
| The multifunction generator option (Option 303) consists of seven waveform generators that can be set independently with up to five simultaneously using the composite modulation features in AM, FM/PM, and LF out |  |
| <b>Waveform</b>   |  |
| Function generator 1  | Sine, triangle, square, positive ramp, negative ramp, pulse  |
| Function generator 2  | Sine, triangle, square, positive ramp, negative ramp, pulse  |
| Dual function generator   | Sine, triangle, square, positive ramp, negative ramp, phase offset, and amplitude ratio for Tone 2 relative to Tone 1          |
| Swept function generator  | Sine, triangle, square, positive ramp, negative ramp<br>Trigger: free run, trigger key, bus, external, internal, timer trigger |
| Noise generator 1   | Uniform, Gaussian  |
| Noise generator 2   | Uniform, Gaussian  |
| DC  | Only for LF output -5 V to +5 V, nominal   |
| <b>Frequency parameters</b>   |  |
| Sine wave   | 0.1 Hz to 10 MHz, nominal  |
| Triangle, square, ramp, pulse   | 0.1 Hz to 1 MHz, nominal   |
| Noise bandwidth   | 10 MHz, nominal  |
| Resolution  | 0.1 Hz   |
| Frequency accuracy  | Same as RF reference source, nominal   |
| <b>Narrow pulse modulation (Option UNW)<sup>1</sup> () = typical</b>  |  |
| On/off ratio  | (> 80 dB)  |
| Rise/fall times (Tr, Tf)  | < 10 ns; (7 ns)  |
| Minimum pulse width ALC on/off  | ≥ 2 us/≥ 20 ns   |
| Repetition frequency ALC on/off   | 10 Hz to 500 kHz/DC to 10 MHz  |
| Level accuracy (relative to CW) ALC on/off <sup>2</sup>   | < ± 1.0 dB (± 0.5 dB)/( < ± 0.5) dB  |
| Width compression (RF width relative to video out)  | (< 5 ns)   |

1. Pulse specifications apply to frequencies > 100 MHz and power set to > -3 dBm. Operable down to 9 kHz.
2. With power search on.

|   |   |
|---|---|
| Video feed-through <sup>1</sup> $\leq 3$ GHz/ $> 3$ GHz | (< 50 mV/< 5 mV)                            |
| External video delay (ext input to video)               | 30 ns, nominal                              |
| RF delay (video to RF output)                           | 20 ns, nominal                              |
| Pulse overshoot   | (< 15%)                                     |
| Input level   | +1 Vpeak = RF on into 50 $\Omega$ , nominal |

$T_d$  video delay (variable)  
 $T_w$  video pulse width (variable)  
 $T_p$  pulse period (variable)  
 $T_m$  RF delay  
 $T_{rf}$  RF pulse width  
 $T_f$  RF pulse fall time  
 $T_r$  RF pulse rise time  
 $V_{or}$  pulse overshoot  
 $V_f$  Video feedthrough

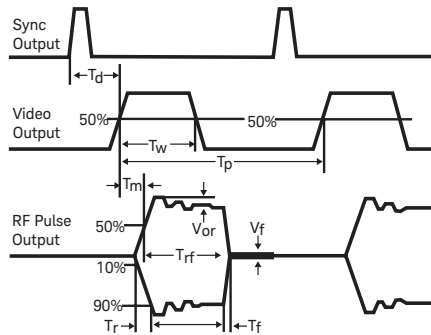

**Internal pulse generator (included with Option UNW)**

|                                   |   |  |
|-----------------------------------|---|--|
| Modes                             | Free-run, square, triggered, adjustable doublet, trigger doublet, gated, and external pulse |  |
| Square wave rate                  | 0.1 Hz to 10 MHz, 0.1 Hz resolution, nominal  |  |
| Pulse period                      | 30 ns to 42 seconds, nominal  |  |
| Pulse width                       | 20 ns to pulse period -10 ns, nominal   |  |
| Resolution                        | 10 ns   |  |
| Adjustable trigger delay          | (-pulse period + 10 ns) to (pulse width -10 ns)   |  |
| Settable delay                    | Free run  | -3.99 to 3.97 $\mu$ s                                  |
|                                   | Triggered   | 0 to 40 s  |
| Resolution (delay, width, period) | 10 ns, nominal  |  |
| Pulse doublets                    | 1st pulse delay   | (Relative to sync out) 0 to 42 s - pulse width - 10 ns |
|                                   | 1st pulse width   | 500 ns to 42 s - delay - 10 ns                         |
|                                   | 2nd pulse delay   | 0 to 42 s - (Delay 1 + Width 2) - 10 ns                |
|                                   | 2nd pulse width   | 20 ns to 42 s - (Delay 1 + Delay 2) - 10 ns            |

**Pulse train generator Option 320 (requires Option UNW)**

|                          |                 |
|--------------------------|-----------------|
| Number of pulse patterns | 2047            |
| On/off time range        | 20 ns to 42 sec |

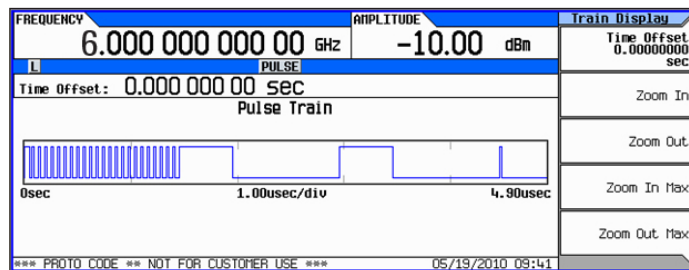

1. Video feed through applies to power levels < +10 dBm.

| <b>Avionics (Option 302)</b>                       |                  |                                      |
|--|------------------|--------------------------------------|
| <b>VOR</b>   |                  |                                      |
| Bearing accuracy                                   |                  | ± 0.1 degrees                        |
| Frequency accuracy                                 |                  | Same as RF reference source, nominal |
| AM accuracy  | 30% depth        | ± 5% of setting                      |
| AM distortion                                      |                  | 2%                                   |
| FM accuracy  | 480 Hz deviation | ± 1.7 Hz                             |
| <b>ILS: localizer and glide slope</b>              |                  |                                      |
| AM accuracy  | 40% depth        | ± 5% of setting                      |
| AM distortion                                      |                  | 2%                                   |
| Difference in depth of modulation (DDM) resolution | Localizer        | 0.0002                               |
|  | Glide slope      | 0.0004                               |
| Difference in depth of modulation (DDM) accuracy   | Localizer        | ± 0.0004 ± 5% of DDM <sup>1</sup>    |
|  | Glide slope      | ± 0.0008 ± 5% of DDM <sup>1</sup>    |
| <b>Marker beacon</b>                               |                  |                                      |
| Marker tone AM accuracy                            | 95% depth        | ± 5% of setting + 1%                 |
| Marker tone AM distortion                          | 95% depth        | 5%                                   |

1. DDM must not be equal to 0.



# Vector Modulation Specifications

## N5172B only

| I/Q modulator external inputs <sup>1</sup>   |  |   |
|--|--|---|
| Bandwidth  | Baseband (I or Q)  | Up to 100 MHz baseband, nominal             |
|  | RF (I+Q)   | Up to 200 MHz RF, nominal                   |
| I or Q offset  | ± 100 mV (200 uV resolution)   |   |
| I/Q gain balance   | ± 4 dB (0.001 dB resolution)   |   |
| I/Q attenuation  | 0 to 50 dB (0.01 dB resolution)  |   |
| Quadrature angle adjustment  | ± 200 units  |   |
| Full scale input drive (I+Q)   | 0.5 V into 50 Ω, nominal   |   |
| Internal I/Q baseband generator adjustments <sup>1,2</sup> (Options 653, 655, and 657) |  |   |
| I/Q offset   | ± 20%  | (0.025% dB resolution)                      |
| I/Q gain   | ± 1 dB   | (0.001 dB resolution)                       |
| Quadrature angle adjustment  | ± 10 °   | (0.01 degrees resolution)                   |
| I/Q phase  | ± 360.00 °   | (0.01 degrees resolution)                   |
| I/Q skew   | ± 500 ns   | (1 picosecond resolution)                   |
| I/Q delay  | ± 250 ns   | (1 picosecond resolution)                   |
| External I/Q outputs <sup>1</sup>  |  |   |
| Impedance  | 50 Ω, nominal per output   |   |
|  | 100 Ω, nominal differential output                                       |   |
| Type   | Single-ended or differential (Option 1EL)                                |   |
| Maximum voltage per output   | 1 V peak-to-peak or 0.5 V peak; into 50 Ω (200 uV resolution)            |   |
| Bandwidth (I, Q)   | Baseband (I or Q)  | 80 MHz, nominal (Option 653, 655, and 657)  |
|  | RF (I+Q)   | 160 MHz, nominal (Option 653, 655, and 657) |
| Amplitude flatness   | ± 0.2 dB measured with channel corrections optimized for I/Q output      |   |
| Phase flatness   | ± 2.5 degrees measured with channel corrections optimized for I/Q output |   |
| Common mode I/Q offset   | ± 1.5 V into 50 Ω (200 uV resolution)                                    |   |
| Differential mode I or Q offset  | ± 50 mV into 50 Ω (200 uV resolution)                                    |   |

1. I/Q adjustments represent user interface nominal parameter ranges and not specifications.
2. Internal I/Q adjustments apply to RF out and I/Q outputs simultaneously.

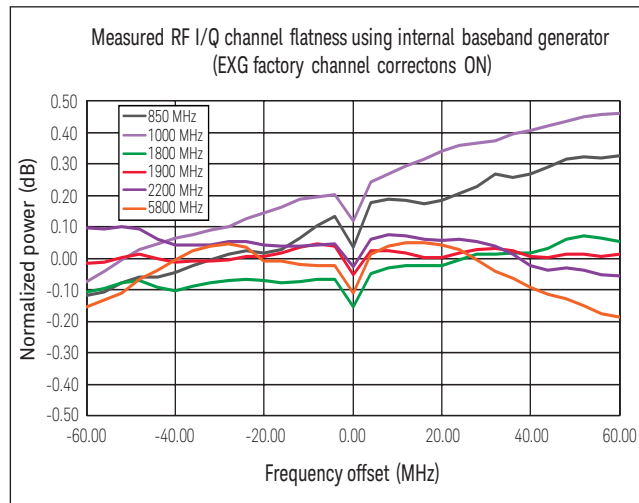
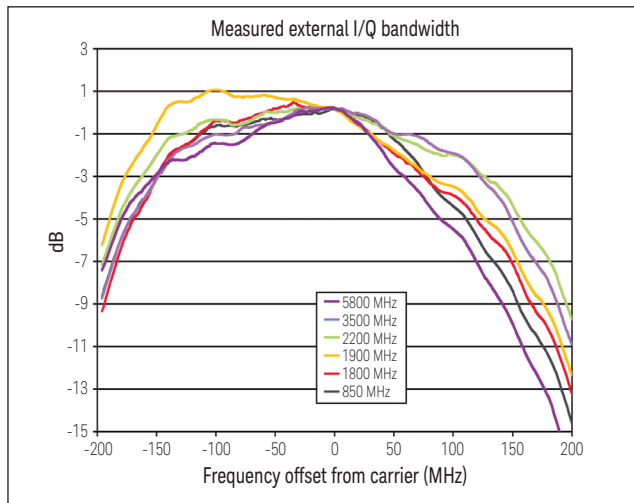

| <b>Internal real-time complex digital I/Q filters (included with Option 653 )</b>   |  |  |
|---|--|--|
| <b>Factory channel correction (256 taps)</b>  |  |  |
| Corrects the linear phase and amplitude response of the baseband I/Q and RF outputs of the signal generator using factory calibration arrays (default mode is off).   |  |  |
| RF amplitude flatness (160 MHz)   | ± 0.2 dB measured  |  |
| RF phase flatness (160 MHz)   | ± 2 degrees measured   |  |
| <b>User channel correction (256 taps)</b>   |  |  |
| Automated routine uses USB power sensor to correct for linear phase and amplitude response of DUT (equalizer). See User Guide for more details.   |  |  |
| Max RF amplitude flatness correction  | ± 15 dB  |  |
| Max RF phase flatness correction  | ± 20 degrees   |  |
| <b>Equalization filter (256 taps)</b>   |  |  |
| User can download and apply inverse or custom phase and amplitude response coefficients from tools such as MATLAB, 89600 VSA, or SystemVue to correct for linear errors of DUT/system. See User Guide for more details. |  |  |
| <b>Baseband generator (Options 653 and 655)</b>   |  |  |
| Channels  | 2 [I and Q]  |  |
| Resolution  | 16 bits [1/65,536]   |  |
| Sample rate   | Option 653   | 100 Sa/s to 75 Msa/s   |
|   | Option 653 and 655   | 100 Sa/s to 150 Msa/s  |
|   | Option 653, 655, and 657   | 100 Sa/s to 200 Msa/s  |
| RF (I+Q) bandwidth  | Option 653   | 60 MHz, nominal  |
|   | Option 653 and 655   | 120 MHz, nominal   |
|   | Option 653, 655, and 657   | 160 MHz, nominal   |
| Interpolated DAC rate   | 800 MHz (waveforms only need OSR = 1.25 )  |  |
| Frequency offset range  | ± 80 MHz   |  |
| Digital sweep modes   | In list sweep mode each point in the list can have independent waveforms (N5172B) along with user definable frequencies and amplitudes; see the Amplitude and Frequency Specifications sections for more detail. |  |
| Waveform switching speed <sup>1</sup>   | SCPI mode  | ≤ 5 ms, measured (standard)<br>≤ 1.2 ms, measured (Option UNZ) |
|   | List/step sweep mode   | ≤ 5 ms, measured (standard)<br>≤ 900 us, measured (Option UNZ) |
| Waveform transfer rates<br>(measured, no markers, unencrypted)  | FTP LAN to internal SSD  | 10.7 MB/sec or 2.67 Msa/sec                                    |
|   | Internal SSD to FTP LAN  | 7.7 MB/sec 1.92 Msa/sec  |
|   | FTP LAN to BBG   | 8.2 MB/sec or 2.05 Msa/sec                                     |
|   | FTP LAN to BBG encrypted   | 4 MB/sec or 1 Msa/sec  |
|   | USB to BBG   | 19 MB/sec or 4.75 Msa/sec                                      |
|   | BBG to USB   | 1.2 MB/sec or 300 Ksa/sec                                      |
|   | Internal SSD to BBG  | 48 MB/sec or 12 Msa/sec  |
|   | BBG to internal SSD  | 1.2 MB/sec or 300 Ksa/sec                                      |
|   | SD card to BBG (Option 006)  |  |
| BBG to SD card (Option 006)   | 845 KB/sec or 211 Ksa/sec  |  |

1. SCPI mode switching speed applies when waveforms are pre-loaded in list sweep and sample rate ≥ 10 Msa/s.

|   |   |   |   |  |  |
|---|---|---|---|--|--|
| Arbitrary waveform memory   | Maximum playback capacity   | 32 Msa (standard)                       |   |  |  |
|   |   | 256 Msa (Option 021)                    |   |  |  |
|   |   | 512 Msa (Option 022)                    |   |  |  |
| Waveform segments   | Maximum storage capacity including markers  | 3 GBytes/800 Msa (standard)             |   |  |  |
|   |   | 30 GBytes/7.5 Gsa (Option 009)          |   |  |  |
|   |   | 8 GBytes / 2 Gsa (Option 006)           |   |  |  |
| Waveform sequences  | Segment length  | 60 samples to 32 Msa (standard)         |   |  |  |
|   |   | 60 samples to 256 Msa (Option 021)      |   |  |  |
|   |   | 60 samples to 512 Msa (Option 022)      |   |  |  |
|   |   | Minimum memory allocation per segment   | 256 samples                                   |  |  |
| Waveform sequences  | Maximum number of segments  | 8192                                    |   |  |  |
|   |   | Maximum number of sequences             | > 2000 depending on non-volatile memory usage |  |  |
|   |   |   | Maximum number of segments/sequence           | 32,000 (standard)                      |  |
| 4 million (Option 021 or 022)   |   |   |   |  |  |
| Triggers  | Maximum number of repetitions   | 65,535                                  |   |  |  |
|   |   | Types                                   | Continuous, single, gated, segment advance    |  |  |
|   | Source  |   | Trigger key, external, bus ( GPIB, LAN, USB)  |  |  |
|   |   |   | Modes   | Continuous                             | Free run, trigger and run, reset and run           |
|   |   |   |   | Single                                 | No retrigger, buffered trigger, restart on trigger |
|   |   | Gated                                   |   | Negative polarity or positive polarity |  |
|   | Segment advance   | Single or continuous                    |   |  |  |
|   | External coarse delay time  | 5 ns to 40 s                            |   |  |  |
|   | External coarse delay resolution  | 5 ns                                    |   |  |  |
|   | Trigger latency (Single trigger only)   | 356 ns + 1 sample clock period, nominal |   |  |  |
| Trigger accuracy (Single trigger only)  | ± 2.5 ns, nominal   |   |   |  |  |
| Single trigger - restart on trigger mode will initiate a FIFO clear. Therefore, the latency includes re-filling the buffer. The latency is 8 μs + (1406 x sample period) ± 1 sample clock period, nominal |   |   |   |  |  |
| Multi-baseband generator synchronization mode (multiple sources)  | Fan out   | 1 master and up to 15 slaves            |   |  |  |
|   | Trigger repeatability   | < 1 ns, nominal                         |   |  |  |
|   | Trigger accuracy  | Same as normal mode                     |   |  |  |
|   | Trigger latency   | Same as normal mode                     |   |  |  |
|   | Fine trigger delay range  | See Internal I/Q Baseband section       |   |  |  |
|   | Fine trigger delay resolution   | See Internal I/Q Baseband section       |   |  |  |
|   | I/Q phase adjustment range  | See Internal I/Q Baseband section       |   |  |  |
| Markers   | Markers are defined in a segment during the waveform generation process, or from the front panel; a marker can also be routed to the RF blanking, ALC hold functions, and alternate amplitude; see Users Guide for more information |   |   |  |  |
|   | Marker polarity   | Negative, positive                      |   |  |  |
|   | Number of markers   | 4                                       |   |  |  |
|   | RF blanking/burst on/off ratio  | > 80 dB                                 |   |  |  |
|   | Alternate amplitude control switching speed   | See amplitude section                   |   |  |  |

|   |  |   |
|---|--|---|
| Real-time modulation FIR filter:  | Nyquist, root-Nyquist, WCDMA, EDGE, Gaussian, rectangular, APCO<br>25 C4FM, IS-95, User FIR<br>(Applies real-time FIR filtering when playing waveforms with OSR=1. Helps reduce waveform size for long simulation times. Option 660 not required). |   |
| <b>Real-time baseband generator (Option 660)</b>  |  |   |
| Real-time baseband generator required for real-time Signal Studio applications <sup>1</sup>   | Cellular real-time applications  | LTE-FDD, LTE-TDD, HSPA+/W-CDMA, GSM/EDGE, cdma2000® |
|   | Real-time navigation   | GPS, GLONASS, Galileo                               |
|   | Real-time video applications   | DVB-T/T2/H/S/S2/C/J.83 Annex A/C, ISDB-T/           |
|   | Note: Option 660 is not required for real-time custom modulation (Option 431)  |   |
|   | Memory: Shares memory with Options 653, 655, and 657   |   |
|   | Triggering: Same as Options 653, 655, and 657  |   |
| Markers: 3 markers available, all other features are same as Options 653, 655, and 657  |  |   |
| <b>Digital baseband inputs/outputs (Option 003/004)</b>   |  |   |
| Options 003 and 004 activate the rear panel digital I/Q bus and enables connectivity to the N5102A digital signal interface module. In output mode (003), you can deliver realistic complex-modulated signals such as LTE, GPS, WLAN, custom pulses and many others directly to your digital devices and subsystems. In the input mode (004), the interface module ports your digital input to the signal generator's baseband system, providing a quick and easy way of upconverting to calibrated analog I/Q, IF, or RF frequencies. In both operating modes, the interface module adapts to your device with the logic type, data format, clock features, and signaling you require. |  |   |
| <b>Data (requires N5102A)</b>   |  |   |
| Digital data format   | User-selectable: 2's complement or binary offset, I/Q (I, I-bar, Q, Q-bar) or digital IF output (real, imaginary)  |   |
| Data port   | Dual 16-bit data buses support parallel, parallel I/Q interleaved, parallel QI interleaved, or serial port configuration   |   |
| N5102A connectors (breakout boards)   | 144-pin Tyco Z-Dok+ connects to break-out boards (included with N5102A) that interface with the following connector types: 68-pin SCSI, 38-pin dual AMP Mictor, 100-pin dual Samtec, 20-pin dual 0.1 inch headers, 40-pin dual 0.1 inch headers    |   |
| Logic types   | Single-ended: LVTTTL, 1.5V CMOS, 1.8V CMOS, 2.5V CMOS, 3.3V CMOS   |   |
|   | Differential: LVDS   |   |
| Data output resampling  | EXG baseband output is resampled to the arbitrary clock rate set by the user via real-time curve-fit calculations.   |   |

1. See [www.keysight.com/find/signalstudio](http://www.keysight.com/find/signalstudio) for more information.

| <b>Clock (requires N5102A)</b>                 |  |
|--|--|
| Clock input                                    | User selectable: internal clock, device under test clock, or external clock (via SMA or breakout board)<br>N5102A SMA Ext Clock In connector: 50 $\Omega$ , 0 dBm nominal, 1 to 400 MHz  |
| Clock output                                   | User selectable: via breakout board or SMA Clock Out connector<br>N5102A SMA Clock Out connector: 2 Vpp into load > 5 K $\Omega$ from 1 to 100 kHz, 400 mVpp into 50 $\Omega$ load from 100 kHz to 400 MHz                                     |
| Sample rate (limited by EXG sample rate)       | User-selectable in parallel mode up to a maximum 200 MHz, but limited by other user settings (see N5102A users guide for more details).<br>User-selectable in serial mode, the maximum rate is 400 MHz/word size.                              |
| Bit rate (limited by EXG sample rate)          | Parallel Up to 200 MHz x word size (1.6 Gbps LVDS, CMOS and LVTTTL) per parallel bus, 2 parallel buses available<br>Serial Up to 400 MHz per serial line (400 Mbps LVDS) or 150 MHz per serial line (150 Mbps (CMOS/LVTTTL) 32 lines available |
| Clocks per sample                              | In parallel output mode, the data sample can be held for 1, 2 or 4 clock cycles  |
| Clock to data skew                             | Coarse adjustment in 90° steps from 0 to 270°; fine-adjustment in increments of 100 ps up to 5 ns  |
| Clock polarity                                 | Clock signals may be inverted  |
| Frequency reference input                      | 1 to 100 MHz BNC, 50 $\Omega$ , 3 dBm $\pm$ 6 dB,  |
| Power supply (included on N5102A)              | Output: 5 V, 4 A DC  |
| <b>AWGN (Option 403)</b>                       |  |
| Type   | Real-time, continuously calculated, and played using DSP   |
| Modes of operation                             | Standalone or digitally added to signal played by arbitrary waveform or real-time baseband generator   |
| Bandwidth                                      | With Option 653 1 Hz to 60 MHz<br>With Option 653 and 655 1 Hz to 120 MHz<br>With Option 653, 655, and 657 1 Hz to 160 MHz   |
| Crest factor                                   | 15 dB  |
| Randomness                                     | 90 bit pseudo-random generation, repetition period 313 x 10 <sup>9</sup> years   |
| Carrier-to-noise ratio                         | $\pm$ 100 dB when added to signal  |
| Carrier-to-noise ratio formats                 | C/N, Eb/No   |
| Carrier-to-noise ratio error                   | Magnitude error $\leq$ 0.2 dB at baseband I/Q outputs  |
| <b>Custom modulation Arb Mode (Option 431)</b> |  |
| Modulation                                     | PSK BPSK, QPSK, OQPSK, $\pi$ /4DQPSK, gray coded and unbalanced QPSK, 8PSK, 16PSK, D8PSK<br>QAM 4, 16, 32, 64, 128, 256, 1024 (and 89600 VSA mappings)<br>FSK Selectable: 2, 4, 8, 16, C4FM<br>MSK 0 to 100°<br>ASK 0 to 100%                  |
| Multicarrier                                   | Number of carriers Up to 100 (limited by a max bandwidth of 160 MHz depending on symbol rate and modulation type)<br>Frequency offset (per carrier) Up to -80 to +80 MHz<br>Power offset (per carrier) 0 dB to -40 dB                          |
| Symbol rate                                    | 50 sps to 100 Msps   |
| Filter types                                   | Nyquist, root-Nyquist, Gaussian, rectangular, APCO 25 C4FM, user   |
| Quick setup modes                              | APCO 25w/C4FM, APCO25 w/CQPSK, <i>Bluetooth</i> <sup>®</sup> , CDPD, DECT, EDGE, GSM, NADC, PDC, PHS, PWT, TETRA   |
| Data   | Random only  |

| Custom modulation real-time mode (Option 431) (Does not require Option 660) |  |  |   |  |
|---|--|--|---|--|
| Modulation  | PSK  | BPSK, QPSK, OQPSK, $\pi/4$ DQPSK, gray coded and unbalanced QPSK, 8PSK, 16PSK, D8PSK, IS95 QPSK, IS95 OQPSK, EDGE, HDQPSK, SOQPSK  |   |  |
|   | QAM  | 4, 16, 32, 64, 128, 256, 1024 (and 89600 VSA mappings)   |   |  |
|   | FSK  | Selectable   | 2,4,8, 16 level symmetric, C4FM, HCPM   |  |
|   |  | User-defined   | Custom map of up to 16 deviation levels |  |
|   |  | Max deviation  | 20 MHz                                  |  |
|   | MSK  | 0 to 100°  |   |  |
|   | ASK  | 0 to 100%  |   |  |
|   | DVB-S2 APSK  | 16APSK 2/3, 16APSK 3/4, 16APSK 4/5, 16APSK 5/6, 16APSK 8/9, 16APSK 9/10, 32APSK 3/4, 32APSK 4/5, 32APSK 5/6, 32APSK 8/9, 32APSK 9/10   |   |  |
| Custom I/Q  | Custom map of 1024 unique values   |  |   |  |
| Frequency offset  | Up to -80 MHz to +80 MHz   |  |   |  |
| Symbol rate   | Internal generated data  | 1 sps to 100 Msps and max of 10 bits per symbol (Option 653 + 655 + 657)   |   |  |
|   | External serial data   | 1 sps to [(50 Mbits/sec)/(#bits/symbol)]   |   |  |
| Filter types  | Selectable   | Nyquist, root-Nyquist, Gaussian, rectangular, APCO 25 (phase 1 and 2 UL and DL), IS-95, WCDMA, EDGE (wide and HSR)   |   |  |
|   |  | IS-95 w/EQ, IS-95 Mod, IS-95 Mod w/EQ, HDQPSK, APCO25 HCPM, SOQPSK-TG  |   |  |
|   | Custom FIR   | 16-bit resolution, up to 64 symbols long, automatically resampled to 1024 coefficients (max)<br>> 32 to 64 symbol filter: symbol rate $\leq$ 12.5 MHz<br>> 16 to 32 symbol filter: symbol rate $\leq$ 25 MHz<br>Internal filters switch to 16 tap when symbol rate is between 25 and 100 MHz |   |  |
| Quick setup modes   | APCO 25 with (C4FM, CQPSK, HCPM, HDQPSK), TETRA , <i>Bluetooth</i> , CDPD, DECT, EDGE, GSM, NADC, PDC, PHS, PWT, WorldSpace, Iridium, ICO, CT2, TFTS |  |   |  |
|   | 16APSK 2/3, 16APSK 3/4, 16APSK 4/5, 16APSK 5/6, 16APSK 8/9, 16APSK 9/10, 32APSK 3/4, 32APSK 4/5, 32APSK 5/6, 32APSK 8/9, 32APSK 9/10, SOQPSK         |  |   |  |
| Trigger delay   | Range  | 0 to 1,048,575 bits  |   |  |
|   | Resolution   | 1 bit  |   |  |
| Data types  | Internally generated   | Pseudo-random patterns   | PN9, PN11, PN15, PN20, PN23             |  |
|   |  | Repeating sequence   | Any 4-bit sequence                      |  |
|   | Direct-pattern RAM [PRAM] max size<br>Note: Used for custom TDMA/non-standard framing  | 32 Mb (standard)   |   |  |
|   |  | 512 Mb (Option 021)  |   |  |
|   |  | 1024 Mb (Option 022)   |   |  |
|   | User file  | 32 MB (standard)   |   |  |
|   |  | 256 MB (Option 021)  |   |  |
| Externally streamed data (via AUX I/O)                                      | Type   | Serial data  |   |  |
|   | Inputs/outputs <sup>1</sup>  | Data, symbol sync, bit clock   |   |  |
| Internal burst shape (varies with bit rate)                                 | Rise/fall time range   | Up to 30 bits  |   |  |
|   | Rise/fall delay range  | -15 to +15 bits  |   |  |

1. Bit clock and symbol sync inputs will be available in future firmware release.

| Multitone and two-tone (Option 430)            |   |                                  |
|--|---|----------------------------------|
| Number of tones                                | 2 to 512, with selectable on/off state per tone   |                                  |
| Frequency spacing                              | 100 Hz to 160 MHz (with Option 653, 655, and 657) |                                  |
| Phase (per tone)                               | Fixed or random                                   |                                  |
| Real-time phase noise impairments (Option 432) |   |                                  |
| Close-in phase noise characteristics           | -20 dB per decade                                 |                                  |
| Far-out phase noise characteristics            | -20 dB per decade                                 |                                  |
| Mid-frequency characteristics                  | Start frequency (f1)                              | Offset settable from 0 to 77 MHz |
|  | Stop frequency (f2)                               | Offset settable from 0 to 77 MHz |
| Phase noise amplitude level (L(f))             | User selected; max degradation dependent on f2    |                                  |

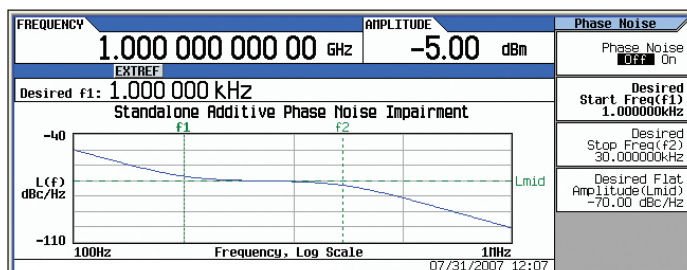

| 3GPP W-CDMA distortion performance <sup>1,2</sup> |                                      |                  |                        |         |                        |         |                            |         |
|---|--------------------------------------|------------------|------------------------|---------|------------------------|---------|----------------------------|---------|
|   |                                      |                  | Standard               |         | Option UNV             |         | Option UNV with Option 1EA |         |
| Power level                                       |                                      |                  | $\leq 2 \text{ dBm}^2$ |         | $\leq 2 \text{ dBm}^2$ |         | $\leq 5 \text{ dBm}^2$     |         |
| Offset  | Configuration                        | Frequency        | Spec                   | Typ     | Spec                   | Typ     | Spec                       | Typ     |
| Adjacent (5 MHz)                                  | 1 DPCH, 1 carrier                    | 1800 to 2200 MHz | -69 dBc                | -73 dBc | -71 dBc                | -75 dBc | -71 dBc                    | -75 dBc |
| Alternate (10 MHz)                                |                                      |                  | -70 dBc                | -75 dBc | -72 dBc                | -77 dBc | -71 dBc                    | -77 dBc |
| Adjacent (5 MHz)                                  | Test model 1 with 64 DPCH, 1 carrier | 1800 to 2200 MHz | -68 dBc                | -70 dBc | -71 dBc                | -73 dBc | -71 dBc                    | -72 dBc |
| Alternate (10 MHz)                                |                                      |                  |                        | -73 dBc | -72 dBc                | -76 dBc | -71 dBc                    | -76 dBc |
| Adjacent (5 MHz)                                  | Test model 1 with 64 DPCH, 4 carrier | 1800 to 2200 MHz | -63 dBc                | -65 dBc | -65 dBc                | -67 dBc | -64 dBc                    | -66 dBc |
| Alternate (10 MHz)                                |                                      |                  |                        | -64 dBc | -66 dBc                | -66 dBc | -68 dBc                    | -66 dBc |

- ACPR specifications apply when the instrument is maintained within  $\pm 20$  to  $30^\circ\text{C}$ .
- This is rms power. Convert from rms to peak envelope power (PEP) with the following equation:  $\text{PEP} = \text{rms power} + \text{crest factor}$  (for example, 3GPP test model 1 with 64 DPCH has a crest factor 11.5 dB, therefore at +5 dBm rms, the PEP = 5 dBm + 11.5 dB = +16.5 dBm PEP).

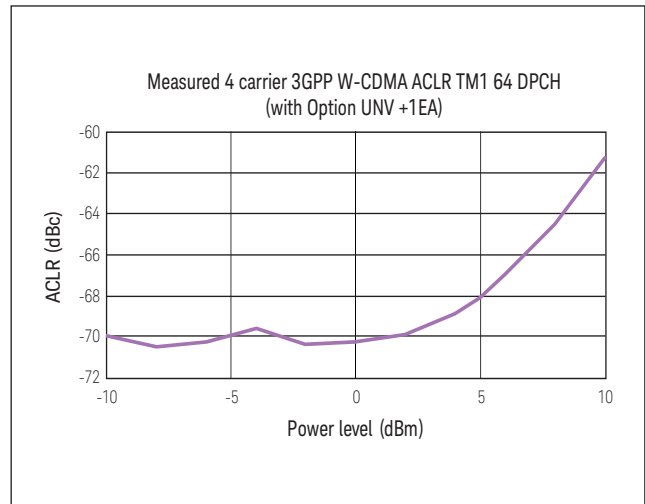
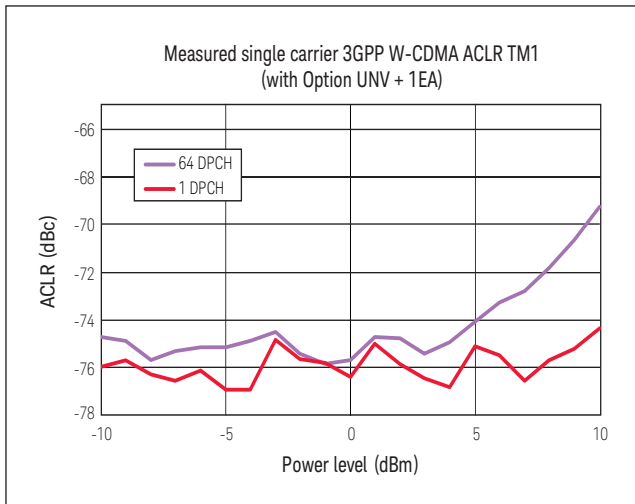

| 3GPP LTE-FDD distortion performance <sup>1</sup> |                 |                  | Standard             |         | Option UNV           |         | Option UNV with Option 1EA |         |
|--|-----------------|------------------|----------------------|---------|----------------------|---------|----------------------------|---------|
| Power level                                      |                 |                  | ≤ 2 dBm <sup>2</sup> |         | ≤ 2 dBm <sup>2</sup> |         | ≤ 5 dBm <sup>2</sup>       |         |
| Offset   | Configuration   | Frequency        | Spec                 | Typ     | Spec                 | Typ     | Spec                       | Typ     |
| Adjacent (10 MHz) <sup>3</sup>                   | 10 MHz E-TM 1.1 | 1800 to 2200 MHz | -64 dBc              | -66 dBc | -67 dBc              | -69 dBc | -64 dBc                    | -67 dBc |
| Alternate (20 MHz) <sup>3</sup>                  | QPSK            |                  | -66 dBc              | -68 dBc | -69 dBc              | -71 dBc | -69 dBc                    | -71 dBc |

1. ACPR specifications apply when the instrument is maintained within ± 20 to 30 °C.
2. This is rms power. Convert from rms to peak envelope power with the following equation: PEP = rms power + crest factor (for example, 3GPP test model 1 with 64 DPCH has a crest factor 11.5 dB, therefore at +5 dBm rms, the PEP = 5 dBm + 11.5 dB = +16.5 dBm PEP).
3. ACPR measurement configuration: reference channel integration BW: 9.015 MHz, offset channel integration bandwidth: 9.015 MHz.

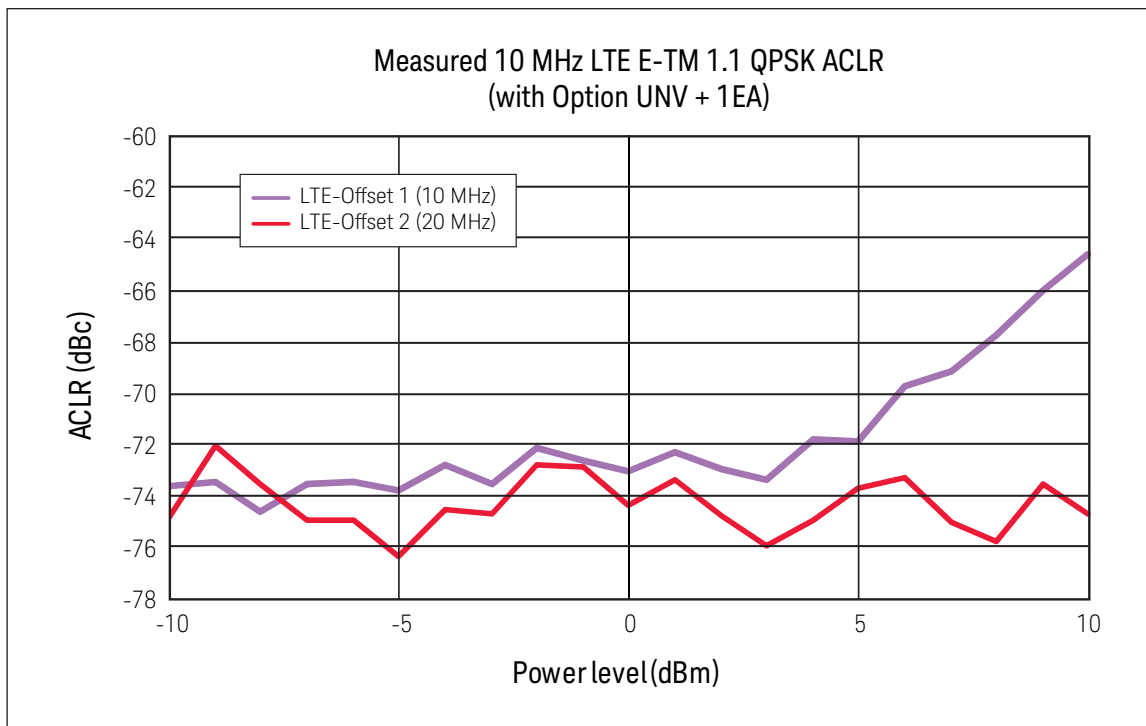



| <b>GSM/EDGE output RF spectrum (ORFS)</b>                     |                            |                                    |                   |                           |                         |                     |
|---|----------------------------|------------------------------------|-------------------|---------------------------|-------------------------|---------------------|
|   |                            |                                    | <b>GSM</b>        |                           | <b>EDGE</b>             |                     |
| Power level   |                            |                                    | < +7 dBm          |                           | < +7 dBm                |                     |
| Offset  | Configuration              | Frequency <sup>1</sup>             | Standard, typical | Option UNV, typical       | Standard, typical       | Option UNV, typical |
| 200 kHz   | 1 normal timeslot, bursted | 800 to 900 MHz<br>1800 to 1900 MHz | -34 dBc           | -36 dBc                   | -37 dBc                 | -38 dBc             |
| 400 kHz   |                            |                                    | -69 dBc           | -70 dBc                   | -69 dBc                 | -70 dBc             |
| 600 kHz   |                            |                                    | -81 dBc           | -82 dBc                   | -80 dBc                 | -81 dBc             |
| 800 kHz   |                            |                                    | -82 dBc           | -83 dBc                   | -82 dBc                 | -83 dBc             |
| 1200 kHz  |                            |                                    | -84 dBc           | -85 dBc                   | -83 dBc                 | -84 dBc             |
| <b>3GPP2 cdma2000 distortion performance, typical</b>         |                            |                                    |                   |                           |                         |                     |
|   |                            |                                    | <b>Standard</b>   | <b>Option UNV</b>         | <b>Option UNV + 1EA</b> |                     |
| Power level <sup>2</sup>                                      |                            |                                    | ≤ 2 dBm           | ≤ 2 dBm                   | ≤ 5 dBm                 |                     |
| <b>Offset</b>   | <b>Configuration</b>       | <b>Frequency (1)</b>               | <b>Typical</b>    | <b>Typical</b>            | <b>Typical</b>          |                     |
| 885 kHz to 1.98 MHz   | 9 channel forward link     | 800 to 900 MHz                     | -78 dBc           | -79 dBc                   | -77 dBc                 |                     |
| > 1.98 to 4.0 MHz   |                            |                                    | -86 dBc           | -87 dBc                   | -87 dBc                 |                     |
| > 4.0 to 10 MHz   |                            |                                    | -91 dBc           | -93 dBc                   | -93 dBc                 |                     |
| <b>802.16e Mobile WiMAX™ distortion performance, measured</b> |                            |                                    |                   |                           |                         |                     |
| <b>Power</b>  | <b>Offset<sup>3</sup></b>  | <b>Configuration<sup>4</sup></b>   | <b>Frequency</b>  | <b>Standard, measured</b> | <b>UNV, measured</b>    |                     |
| < -7 dBm  | 10 MHz                     | QPSK                               | 2.5 and 3.5 GHz   | -65 dBc                   | -68 dBc                 |                     |
| Up to +5 dBm  | 10 MHz                     | QPSK                               | 3.5 GHz           | -62 dBc                   | -65 dBc                 |                     |

1. Performance evaluated at bottom, middle, and top of bands shown.
2. This is rms power. Convert from rms to peak envelope power (PEP) with the following equation:  $PEP = rms\ power + crest\ factor$  (for example: 3GPP test model 1 with 64 DPCH has a crest factor > 11 dB, therefore at +5 dBm rms the PEP = 5 dBm + 11 dB = +16 dBm PEP).
3. Measurement configuration: reference channel integration BW: 9.5 MHz, offset channel integration BW: 9 MHz, channel offset: 10 MHz.
4. 802.16e WiMAX signal configuration—bandwidth: 10 MHz, FFT: 1024, frame length: 5 ms, guard period: 1/8, symbol rolloff: 5%, content: 30 symbols of PN9 data.

| EVM performance data <sup>1,2</sup> |                                    |          |                                    |       |   |      |                  |       |                      |      |          |
|-------------------------------------|------------------------------------|----------|------------------------------------|-------|---|------|------------------|-------|----------------------|------|----------|
| Format                              | GSM                                |          | EDGE                               |       | cdma2000/IS95A                                |      | W-CDMA           |       | LTE FDD <sup>3</sup> |      |          |
| Modulation type                     | GMSK (burst)                       |          | 3pi/8 8PSK (burst)                 |       | QPSK  |      | QPSK             |       | 64 QAM               |      |          |
| Modulation rate                     | 270.833 kbps                       |          | 70.833 kbps                        |       | 1.2288 Mcps                                   |      | 3.84 Mcps        |       | 10 MHz BW            |      |          |
| Channel configuration               | 1 timeslot                         |          | 1 timeslot                         |       | Pilot channel                                 |      | 1 DPCH           |       | E-TM 3.1             |      |          |
| Frequency <sup>4</sup>              | 800 to 900 MHz<br>1800 to 1900 MHz |          | 800 to 900 MHz<br>1800 to 1900 MHz |       | 800 to 900 MHz<br>1800 to 1900 MHz            |      | 1800 to 2200 MHz |       | 1800 to 2200 MHz     |      |          |
| EVM power level                     | ≤ 7 dBm                            |          | ≤ 7 dBm                            |       | ≤ 7 dBm                                       |      | ≤ 7 dBm          |       | ≤ 7 dBm              |      |          |
| EVM power level with Option 1EA     | ≤ 13 dBm                           |          | ≤ 13 dBm                           |       | ≤ 13 dBm                                      |      | ≤ 13 dBm         |       | ≤ 13 dBm             |      |          |
| EVM/global phase error              | Spec                               | Typ      | Spec                               | Typ   | Spec  | Typ  | Spec             | Typ   | Measured             |      |          |
|                                     | ms 0.8 °                           | 0.2 °    | 1.2%                               | 0.75% | 1.3%  | 0.8% | 1.2%             | 0.8%  | 0.2%                 |      |          |
| Format                              | 802.11a/g                          |          | 802.11ac <sup>5</sup>              |       | QPSK  |      | 16 QAM           |       |                      |      |          |
| Modulation type                     | 64 QAM                             |          | 256 QAM                            |       | QPSK  |      | 16 QAM           |       |                      |      |          |
| Modulation rate                     | 54 Mbps                            |          | 80 MHz BW                          |       | 4 Msps (root-Nyquist filter $\alpha = 0.25$ ) |      |                  |       |                      |      |          |
| Frequency <sup>4</sup>              | 2400 to 2484 MHz                   |          | 5.775 GHz                          |       | ≤ 3 GHz                                       |      | ≤ 6 GHz          |       | ≤ 3 GHz              |      | ≤ 6 GHz  |
|                                     | 5150 to 5825 MHz                   |          |                                    |       |   |      |                  |       |                      |      |          |
| EVM power level                     | ≤ -5 dBm                           |          | ≤ -5 dBm                           |       | ≤ 4 dBm                                       |      | ≤ 4 dBm          |       | ≤ 4 dBm              |      | ≤ 4 dBm  |
| EVM power level with Option 1EA     | ≤ 2 dBm                            |          | ≤ 2 dBm                            |       | ≤ 10 dBm                                      |      | ≤ 10 dBm         |       | ≤ 10 dBm             |      | ≤ 10 dBm |
| EVM                                 | Measured                           | Measured | Spec                               | Typ   | Spec  | Typ  | Spec             | Typ   | Spec                 | Typ  |          |
|                                     | 0.3%                               | 0.4%     | 1.2%                               | 0.8%  | 1.9%  | 1.1% | 1.1%             | 0.65% | 1.5%                 | 0.9% |          |

1. EVM specifications apply for the default ARB file setup conditions with the default ARB files supplied with the instrument.
2. EVM specifications apply after execution of I/Q calibration when the instrument is maintained within  $\pm 5$  °C of the calibration temperature.
3. LTE FDD E-TM 3.1, 10 MHz, 64 QAM PDSCCH, full resource block. Measured EVM after DC calibration.
4. Performance evaluated at bottom, middle, and top of bands shown.
5. WLAN 802.11ac 80 MHz, 256 QAM, MCS 8, 7 symbols, no filtering. Channel corrections enabled. Rx equalizer training: preamble only.

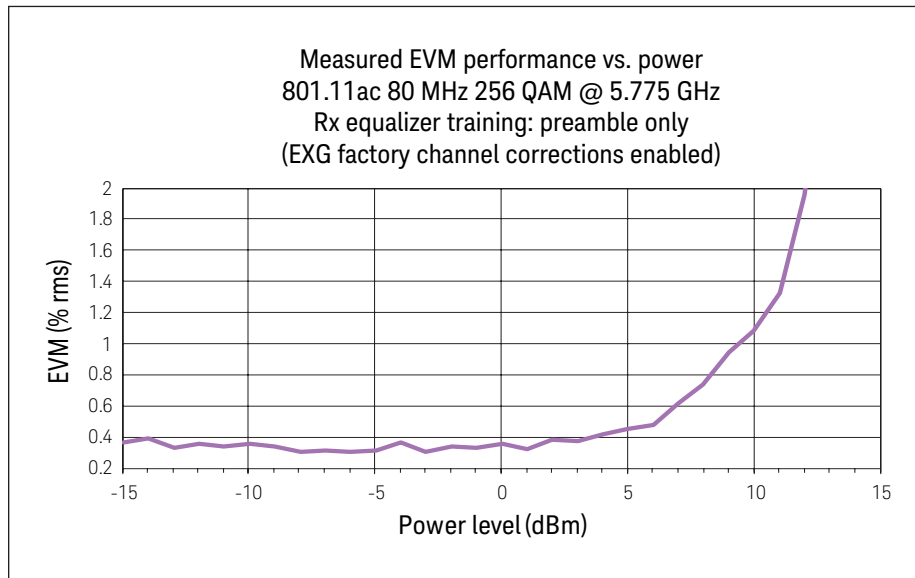

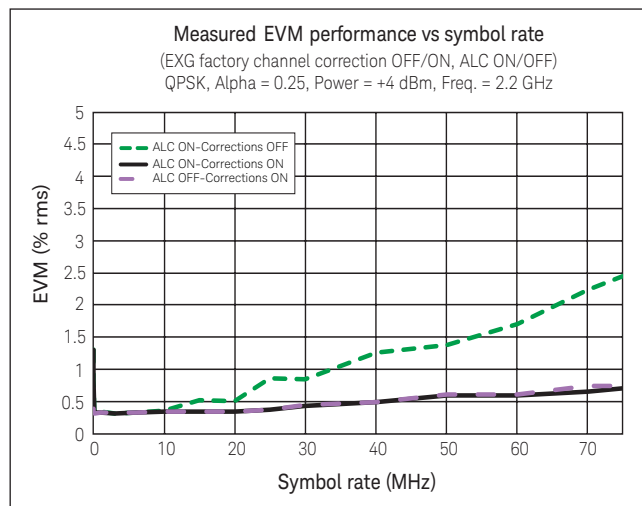
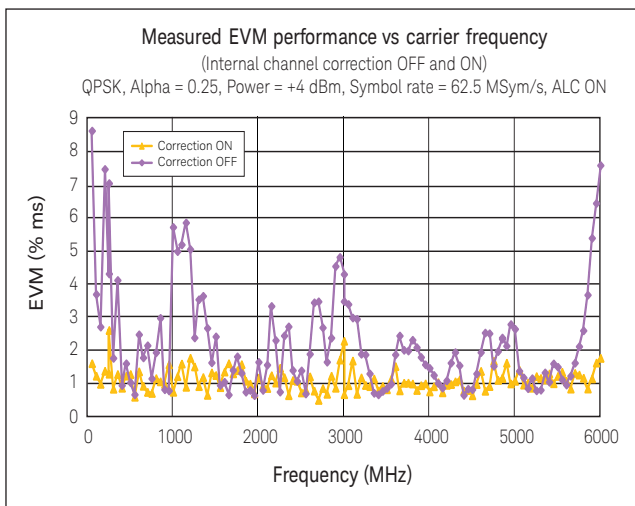
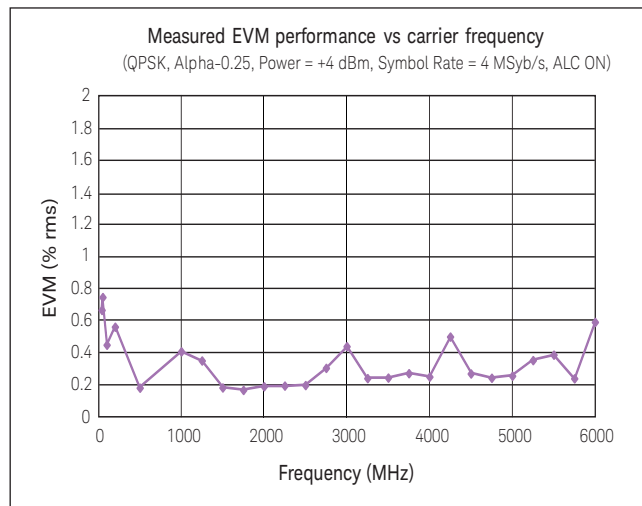
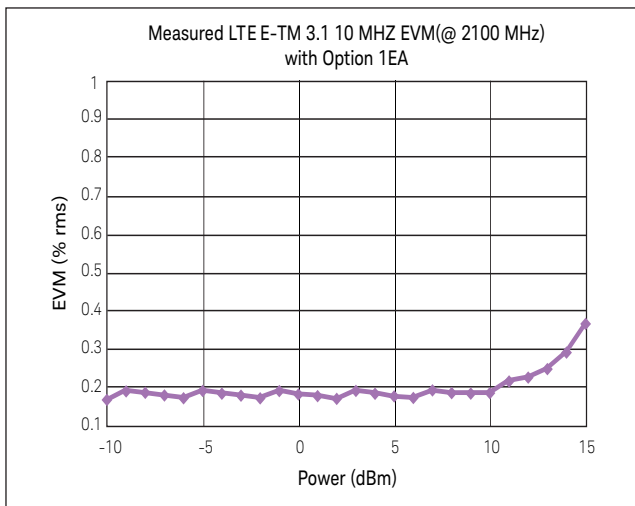

| Bit error rate [BER] analyzer (Option UN7) |  |
|--|--|
| Clock rate                                 | 100 Hz to 60 MHz (usable to 90 MHz)  |
| Data patterns                              | PN9, 11, 15, 20, 23  |
| Resolution                                 | 10 digits  |
| Bit sequence length                        | 100 bits to 4,294 Gbits after synchronization  |
| Other features                             | <ul style="list-style-type: none"> <li>Input clock phase adjustment and gate delay</li> <li>Direct measurement triggering</li> <li>Data and reference signal outputs</li> <li>Real-time display</li> <li>Bit count</li> <li>Error-bit-count</li> <li>Bit error rate</li> <li>Pass/fail indication</li> <li>Valid data and clock detection</li> <li>Automatic re-synchronization</li> <li>Special pattern ignore</li> </ul> |

## General Specifications

|   |   |   |
|---|---|---|
| <b>Remote programming</b>   |   |   |
| Interfaces  | GPIB IEEE-488.2, 1987 with listen and talk<br>LAN 1000BaseT LAN interface, LXI Class C compliant<br>USB Version 2.0   |   |
| Control languages   | SCPI Version 1997.0   |   |
| Compatibility languages   | Keysight Technologies: N5181A\61A, N 5182A\62A, N5183A, E4438C, E4428C, E442xB, E443xB,<br>E8241A, E8244A, E8251A, E8254A, E8247C, E8257C/D, E8267C/D, 8648 Series, 8656B, E8663B,<br>8657A/B, 8662A, 8663A |   |
|   | Aeroflex Inc.: 3410 Series  |   |
|   | Rohde & Schwarz: SMB100A, SMBV100A, SMU200A, SMJ100A, SMATE200A, SMIQ, SML, SMV   |   |
| <b>Power requirements</b>   |   |   |
| 100-120 VAC, 50/60/400 Hz   |   |   |
| 220-240 VAC, 50/60 Hz   |   |   |
| 160 W maximum (N5171B)  |   |   |
| 300 W maximum (N5172B)  |   |   |
| <b>Operating temperature range</b>  |   |   |
| 0 to 55 °C  |   |   |
| <b>Storage temperature range</b>  |   |   |
| -40 to 70 °C  |   |   |
| <b>Operating and storage altitude</b>   |   |   |
| Up to 15,000 feet   |   |   |
| <b>Humidity</b>   |   |   |
| Maximum Relative Humidity (non-condensing): 95%RH up to 40°C, decreases linearly to 45%RH at 55°C. <sup>1</sup>   |   |   |
| <b>Environmental stress</b>   |   |   |
| Samples of this product have been type tested in accordance with the Keysight Environmental Test Manual and verified to be robust against the environmental stresses of storage, transportation and end-use; those stresses include but are not limited to temperature, humidity, shock, vibration, altitude, and power line conditions; test methods are aligned with IEC 60068-2 and levels are similar to MIL-PRF-28800F Class 3 |   |   |
| <b>Safety</b>   |   |   |
| Complies with European Low Voltage Directive 2006/95/EC   |   |   |
| <ul style="list-style-type: none"> <li>- IEC/EN 61010-1, 2nd Edition</li> <li>- Canada: CSA C22.2 No. 61010-1</li> <li>- USA: UL std no. 61010-1, 2nd Edition</li> <li>- German Acoustic statement</li> </ul>   | Acoustic noise emission<br>LpA < 70 dB<br>Operator position<br>Normal position<br>Per ISO 7779  | Geräuschemission<br>LpA < 70 dB<br>Am Arbeitsplatz<br>Normaler Betrieb<br>Nach DIN 45635 t.19 |
| <b>EMC</b>  |   |   |
| Complies with European EMC Directive 2004/108/EC  |   |   |
| <ul style="list-style-type: none"> <li>- IEC/EN 61326-1 or IEC/EN 61326-2-1</li> <li>- CISPR Pub 11 Group 1, class A</li> <li>- AS/NZS CISPR 11</li> <li>- ICES/NMB-001</li> </ul>  | This ISM device complies with Canadian ICES-001;<br>cet appareil ISM est conforme a la norme NMB-001 du Canada  |   |

1. From 40 °C to 55 °C, the maximum % Relative Humidity follows the line of constant dew point

|  |
|--|
| <b>Memory</b>  |
| <ul style="list-style-type: none"> <li>– Memory is shared by instrument states, user data files, sweep list files, waveform sequences, and other files</li> <li>– 3 GB (30 GB with Option 009) memory available in the N5172B</li> <li>– Security Option 006 allows storage of up to 8 GB on SD card</li> <li>– Depending on how the memory is utilized, a maximum of 1000 instrument states can be saved</li> </ul>   |
| <b>No internal non-volatile memory (Option SD0)</b>  |
| <ul style="list-style-type: none"> <li>– Disable/remove any internal non-volatile memory or solid state drive</li> <li>– User will not be able to store any files in the internal memory of the instrument</li> <li>– Not compatible with instrument hardware option 009 (Internal Solid State Memory) and option 660 (Base Band Generator with Real-Time Capability)</li> <li>– Requires firmware B.01.80 or newer</li> </ul>   |
| <b>Security (Option 006)</b>   |
| <ul style="list-style-type: none"> <li>– Removable 8 GB solid state memory (SD card) from rear panel</li> <li>– User can force all files to be stored only on external memory card including instrument states, user data files, sweep list files, waveforms, waveform sequences, and other files.</li> <li>– Memory sanitizing, memory sanitizing on, power on, and display blanking</li> <li>– Note: Read/write speeds to external memory card will be slower compared to internal solid-state drive (Option 009)</li> </ul> |
| <b>Self-test</b>   |
| Internal diagnostic routines test most modules in a preset condition; for each module, if its node voltages are within acceptable limits, the module passes the test   |
| <b>Weight</b>  |
| N5171B: ≤ 13.6 kg (30 lb) net, ≤ 28.6 kg (63 lb) shipping<br>N5172B: ≤ 15.9 kg (35 lb) net, ≤ 30.8 kg (68 lb) shipping   |
| <b>Dimensions</b>  |
| 88 mm H x 426 mm W x 489 mm L (length includes rear panel feet)<br>(3.5 in H x 16.8 in W x 19.2 in L)<br>Max length (L) including RF connector tip to end of rear panel feet is 508 mm (20 in)   |
| <b>Recommended calibration cycle</b>   |
| 36 months  |
| <b>ISO compliant</b>   |
| This instrument is manufactured in an ISO-9001 registered facility in concurrence with Keysight Technologies' commitment to quality.   |

## Inputs and Outputs

|  |  |
|--|--|
| <b>Front panel connectors</b>  |  |
| RF output  | Outputs the RF signal via a precision N type female connector; see output section for reverse power protection information   |
| I and Q inputs   | BNC input accepts "in-phase" and "quadrature" input signals for I/Q modulation; nominal input impedance is 50 Ω, damage levels are 1 Vrms and 5 Vpeak  |
| USB 2.0  | Used with a memory stick for transferring instrument states, licenses and other files into or out of the instrument; also used with U2000, U848X, and U202X Series USB power sensors                             |
| <b>Rear panel connectors</b>   |  |
| <b>Rear panel inputs and outputs are 3.3 V CMOS, unless indicated otherwise; CMOS inputs will accept 5 V CMOS, 3 V CMOS, or TTL voltage levels</b> |  |
| RF output (Option 1EM)   | Outputs the RF signal via a precision N type female connector  |
| I and Q inputs (Option 1EM)  | Accepts "in-phase" and "quadrature" input signals for I/Q modulation SMB connector, nominal input impedance is 50 Ω; damage levels are 1 Vrms and 5 Vpeak; Option 1EM units will come with 2 SMB to BNC adapters |
| I and Q outputs  | BNC outputs the analog I/Q modulation signals from the internal baseband generator; nominal output impedance 50 Ω, DC coupled; damage levels ± 2 V   |
| I bar and Q bar outputs (Option 1EL)   | BNC outputs the complement of the I and Q signals for differential applications;   |

|                         |  |
|-------------------------|--|
| Event 1                 | This connector outputs the programmable timing signal generated by marker 1<br>The marker signal can also be routed internally to control the RF blanking and ALC hold functions; this signal is also available on the AUX I/O connector<br>With bit error rate analyzer (Option UN7) this connector is used for data input<br>Damage levels are $> +8\text{ V}$ and $< -4\text{ V}$   |
| Pattern trigger         | Accepts signal to trigger internal pattern generator to start single pattern output, for use with the internal baseband generators<br>Accepts CMOS signal with minimum pulse width of 10 ns<br>Female BNC<br>Damage levels are $> +8\text{ V}$ and $< -4\text{ V}$   |
| BBTRIG 1                | For arbitrary and real-time baseband generators I/O such as Markers or trigger inputs<br>With bit error rate analyzer (Option UN7) this connector is used for clock input  |
| BBTRIG 2                | For arbitrary and real-time baseband generators I/O such as Markers or trigger inputs<br>With bit error rate analyzer (Option UN7) this connector is used for gate input   |
| Sweep out               | Generates output voltage, 0 to +10 V when the signal generator is sweeping; this output can also be programmed to indicate when the source is settled or output pulse video and is TTL and CMOS compatible in this mode; output impedance $< 1\ \Omega$ , can drive 2 k $\Omega$ ; damage levels are $\pm 15\text{ V}$   |
| Ext 1                   | External AM/FM/PM #1 input; nominal input impedance is 50 $\Omega$ /600 $\Omega$ /1M $\Omega$ , nominal; damage levels are $\pm 5\text{ V}$  |
| Ext 2                   | External AM/FM/PM #2 input; nominal input impedance is 50 $\Omega$ /600 $\Omega$ /1M $\Omega$ , nominal; damage levels are $\pm 5\text{ V}$  |
| LF OUT                  | 0 to 5 V peak into 50 $\Omega$ , -5 V to 5 V offset, nominal   |
| Pulse                   | External pulse modulation input; this input is TTL and CMOS compatible; low logic levels are 0 V and high logic levels are +1 V; nominal input impedance is 50 $\Omega$ ; input damage levels are $\leq -0.3\text{ V}$ and $\geq +5.3\text{ V}$  |
| Trigger in              | Accepts TTL and CMOS level signals for triggering point-to-point in sweep mode; damage levels are $\leq -0.3\text{ V}$ and $\geq +5.3\text{ V}$  |
| Trigger out             | Outputs a TTL and CMOS compatible level signal for use with sweep mode<br>The signal is high at start of dwell, or when waiting for point trigger in manual sweep mode, and low when dwell is over or point trigger is received<br>This output can also be programmed to indicate when the source is settled, pulse synchronization, or pulse video<br>Nominal output impedance 50 $\Omega$<br>Input damage levels are $\leq -0.3\text{ V}$ and $\geq +5.3\text{ V}$ |
| Reference input         | Accepts a 10 MHz reference signal used to frequency lock the internal timebase; Option 1ER adds the capability to lock to a frequency from 1 MHz to 50 MHz; nominal input level -3 to +20 dBm, impedance 50 $\Omega$ , sine or square waveform   |
| 10 MHz out              | Outputs the 10 MHz reference signal used by internal timebase; level nominally +3.9 dBm; nominal output impedance 50 $\Omega$ ; input damage level is +16 dBm  |
| LO in (Option 012)      | Accepts a signal from a master signal generator that is used as the LO for EXG vector in order to configure a phase coherent system; nominal input levels between 0 to +12 dBm; nominal input impedance 50 $\Omega$  |
| LO out (Option 012)     | Outputs a reference signal that can be used in a phase coherent system; nominal output levels between 0 to +12 dBm; nominal output impedance 50 $\Omega$   |
| DAC Clk In (Option 012) | Reserved for future use.   |
| Digital bus I/O         | To be used with PXB or N5102A digital signal interface module  |

|                  |  |
|------------------|--|
| Aux I/O          | <p>Aux I/O port sends and/or receives auxiliary signaling information:<br/> For Option UN7 this connector is used to output reference data, clock, error signals, and more<br/> Output markers to an external device from arbitrary waveform or real-time generation application such as: frame markers, pulse-per-second, even-second, and more.<br/> Input signals from external DUT to modify characteristics of a signal being generated. Such as: changing output power (power control loop testing), advancing or delaying timing (timing advance loop testing), HARQ ACK/NAK delivery (HARQ process loop testing) or streaming external data, clock and symbol synch for custom modulation.<br/> I/O is application specific (CDMA, 3GPP, GNSS, LTE, custom etc). See User Guide or Signal Studio help for more details.<br/> Connector type: 36 pin 3M connector (part number N10236-52B2PC). The mating connector is a 3M 10136-3000 wire mount plug or 3M 10136-8000 IDC plug with a 3M 10336 shell.</p> <p>For Option 431 real-time custom modulation the follow pin numbers are assigned:<br/> Data input = pin 23<br/> Data clock input = pin 29<br/> Symbol sync input = pin 25<br/> Burst input = pin 27<br/> Data output = pin 35<br/> Data clock output = pin 6<br/> Symbol sync output = pin 37<br/> Event 1 output = pin 1<br/> Event 2 output = pin 33</p> |
| USB 2.0          | The USB connector provides remote programming functions via SCPI   |
| LAN (1000 BaseT) | <p>The LAN connector provides the same SCPI remote programming functionality as the GPIB connector and is also used to access the internal Web server and FTP server<br/> Supports DHCP, sockets SCPI, VXI-11 SCPI, connection monitoring, dynamic hostname services, TCP keep alive<br/> LXI class C compliant<br/> Trigger response time for the immediate LAN trigger is 0.5 ms (minimum), 4 ms (maximum), 2 ms, typical; delayed/ alarm trigger is unknown<br/> Trigger output response time is 0.5 ms (minimum), 4 ms (maximum), 2 ms, typical</p>  |
| GPIB             | The GPIB connector provides remote programming functionality via SCPI  |

## Related Literature

### Keysight X-Series Signal Generators

|  |             |
|--|-------------|
| <i>EXG Configuration Guide</i>                 | 5990-9958EN |
| <i>MXG Data Sheet</i>                          | 5991-0038EN |
| <i>MXG Configuration Guide</i>                 | 5990-9959EN |
| <i>N5182BX07 Frequency Extender User Guide</i> | N5182-90001 |
| <i>X-Series Signal Generator Brochure</i>      | 5990-9957EN |
| <i>Signal Studio Software Brochure</i>         | 5989-6448EN |

Learn more at: [www.keysight.com](http://www.keysight.com)

For more information on Keysight Technologies' products, applications or services, please contact your local Keysight office. The complete list is available at: [www.keysight.com/find/contactus](http://www.keysight.com/find/contactus)

